



**Alispo** INTERNATIONAL

Manufacturers & Exporter of Surgical Instruments.

# ALISPO DENTAL INSTRUMENTS

**SCALLERS' CURETTES' CHISELS' FILLING INSTRUMENTS**



CE MARK  
ISO-9001-2000  
cGMP FDA USA

P.O. BOX-2872,  
Roras Road' Muzaffar Pur' P.O. Small Industrial Estate' Sialkot "51310" Pakistan'  
E-Mail: [info@alispo.com](mailto:info@alispo.com); [info@alispo.com.pk](mailto:info@alispo.com.pk) Web: [www.alispo.com](http://www.alispo.com); [www.alispo.com.pk](http://www.alispo.com.pk); [www.laparoscopysupplier.com](http://www.laparoscopysupplier.com)  
Tel: +92-(0)-52-3 555674, 3254475 Fax: +92-(0)-52-3 556652, Cell: +92-(0)-300-8 717 212,



**Alispo** INTERNATIONAL

Manufacturers & Exporter of Surgical Instruments.

Scaler Universal (Goldman-Fox)

**Alispo-80-570**

GOLDMAN-FOX



Universal  
Scaler  
**80-570**



Curette-Anterior  
& Premolar  
**80-571**



Curette-Posterior  
**80-572**



Curette-Molar  
**80-573**



Scalar  
**80-574**



Scalar  
**80-576**



**Alispo** INTERNATIONAL

Manufacturers & Exporter of Surgical Instruments.

Curette-Anterior (Goldman-Fox)

**Alispo-80-571**

GOLDMAN-FOX



Universal  
Scaler  
**80-570**

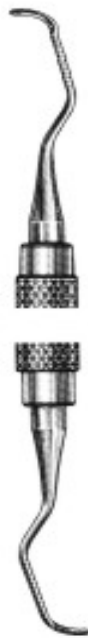

Curette-Anterior  
& Premolar  
**80-571**



Curette-Posterior  
**80-572**



Curette-Molar  
**80-573**



Scalar  
**80-574**



Scalar  
**80-576**



**Alispo** INTERNATIONAL

Manufacturers & Exporter of Surgical Instruments.

Curette-Pesterior (Goldman-Fox)

**Alispo-80-572**

GOLDMAN-FOX



Universal  
Scaler  
**80-570**



Curette-Anterior  
& Premolar  
**80-571**



Curette-Pesterior  
**80-572**



Curette-Molar  
**80-573**



Scalar  
**80-574**



Scalar  
**80-576**



# Alispo INTERNATIONAL

Manufacturers & Exporter of Surgical Instruments.

## Curette-Molar (Goldman-Fox)

### Alispo-80-573

GOLDMAN-FOX



Universal  
Scaler  
80-570



Curette-Anterior  
& Premolar  
80-571



Curette-Posterior  
80-572



Curette-Molar  
80-573



Scalar  
80-574



Scalar  
80-576



**Alispo** INTERNATIONAL

Manufacturers & Exporter of Surgical Instruments.

Scaler (Goldman-Fox)

**Alispo-80-574**

GOLDMAN-FOX



Universal  
Scaler  
80-570

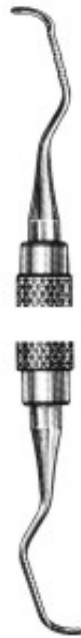

Curette-Anterior  
& Premolar  
80-571



Curette-Posterior  
80-572



Curette-Molar  
80-573



Scaler  
80-574



Scaler  
80-576



# Alispo INTERNATIONAL

Manufacturers & Exporter of Surgical Instruments.

## Scaler (Goldman-Fox)

### Alispo-80-576

GOLDMAN-FOX



Universal  
Scaler  
80-570



Curette-Anterior  
& Premolar  
80-571



Curette-Posterior  
80-572



Curette-Molar  
80-573



Scaler  
80-574



Scaler  
80-576



**Alispo** INTERNATIONAL

Manufacturers & Exporter of Surgical Instruments.

**Knife (Goldman-Fox)**

**Alispo-80-580**

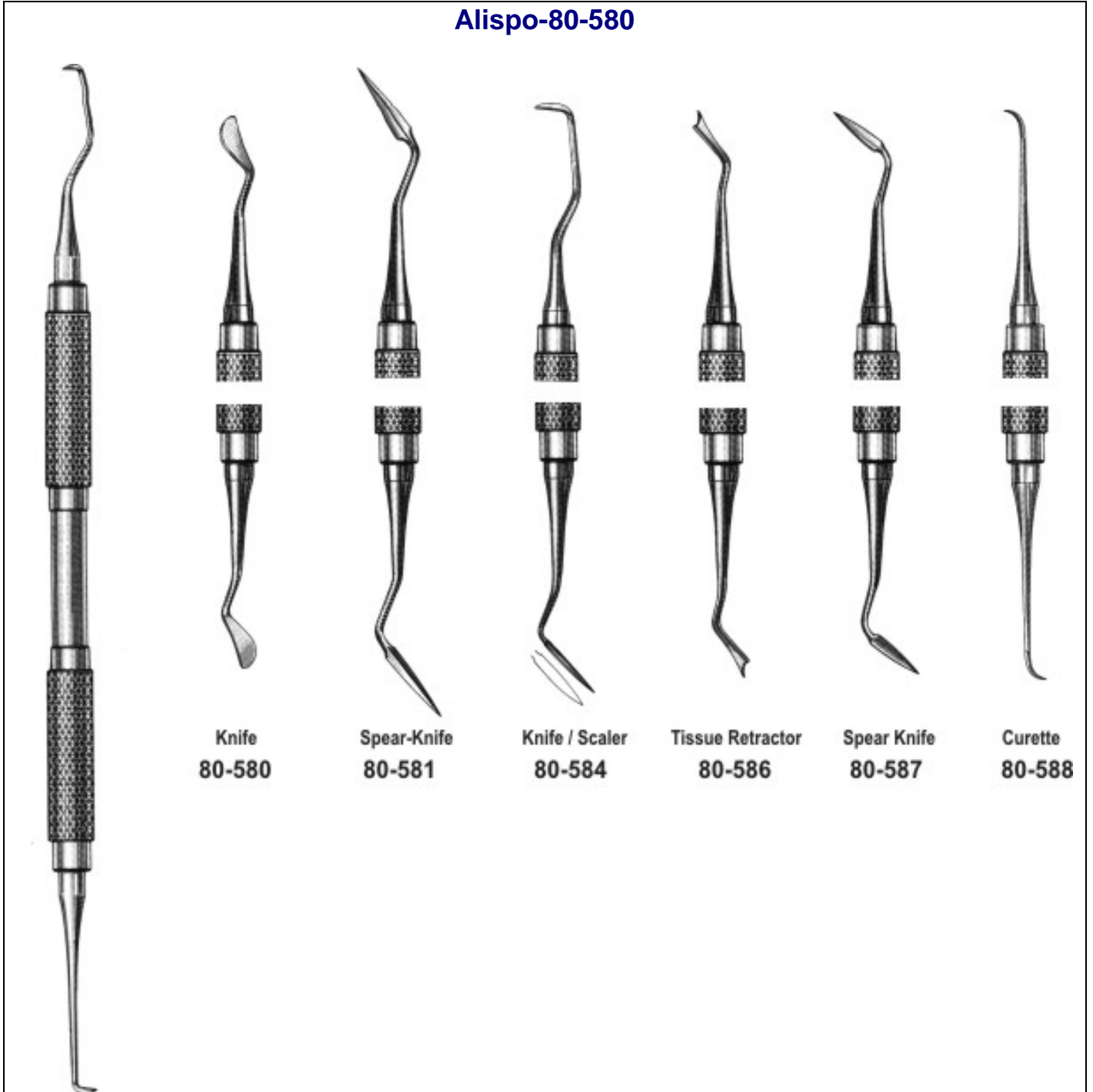

**Knife  
80-580**

**Spear-Knife  
80-581**

**Knife / Scaler  
80-584**

**Tissue Retractor  
80-586**

**Spear Knife  
80-587**

**Curette  
80-588**

P.O. BOX-2872,

Roras Road' Muzaffar Pur' P.O. Small Industrial Estate' Sialkot "51310" Pakistan'

E-Mail: [info@alispo.com](mailto:info@alispo.com); [info@alispo.com.pk](mailto:info@alispo.com.pk) Web: [www.alispo.com](http://www.alispo.com); [www.alispo.com.pk](http://www.alispo.com.pk); [www.laparoscopysupplier.com](http://www.laparoscopysupplier.com)

Tel: +92-(0)-52-3 555674, 3254475 Fax: +92-(0)-52-3 556652, Cell: +92-(0)-300-8 717 212,



**Alispo** INTERNATIONAL

Manufacturers & Exporter of Surgical Instruments.

Spear-Knife (Goldman-Fox)

**Alispo-80-581**

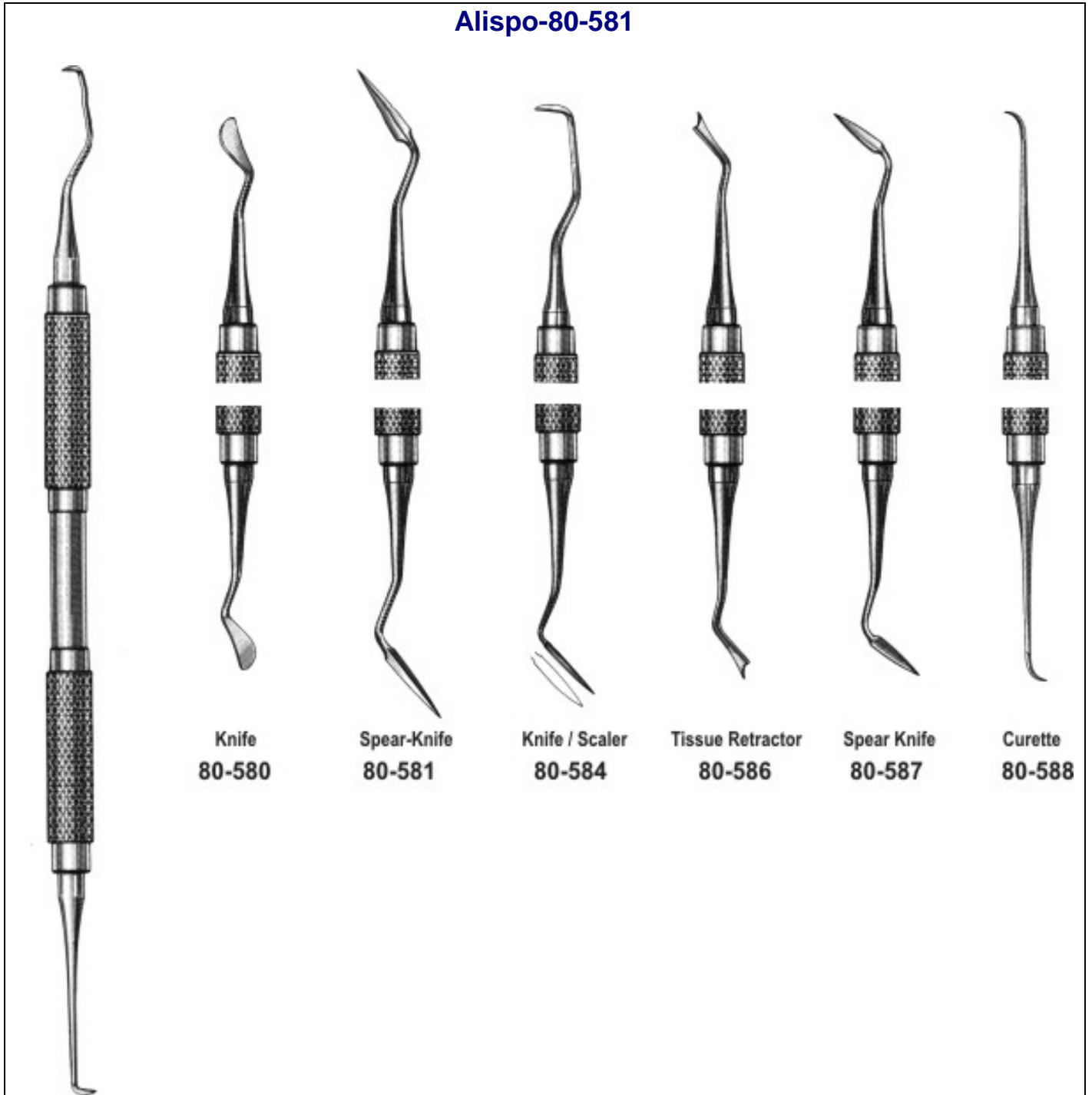

P.O. BOX-2872,

Roras Road' Muzaffar Pur' P.O. Small Industrial Estate' Sialkot "51310" Pakistan'

E-Mail: [info@alispo.com](mailto:info@alispo.com); [info@alispo.com.pk](mailto:info@alispo.com.pk) Web: [www.alispo.com](http://www.alispo.com); [www.alispo.com.pk](http://www.alispo.com.pk); [www.laparoscopysupplier.com](http://www.laparoscopysupplier.com)

Tel: +92-(0)-52-3 555674, 3254475 Fax: +92-(0)-52-3 556652, Cell: +92-(0)-300-8 717 212,



**Alispo** INTERNATIONAL

Manufacturers & Exporter of Surgical Instruments.

Knife/Scaler (Goldman-Fox)

**Alispo-80-584**

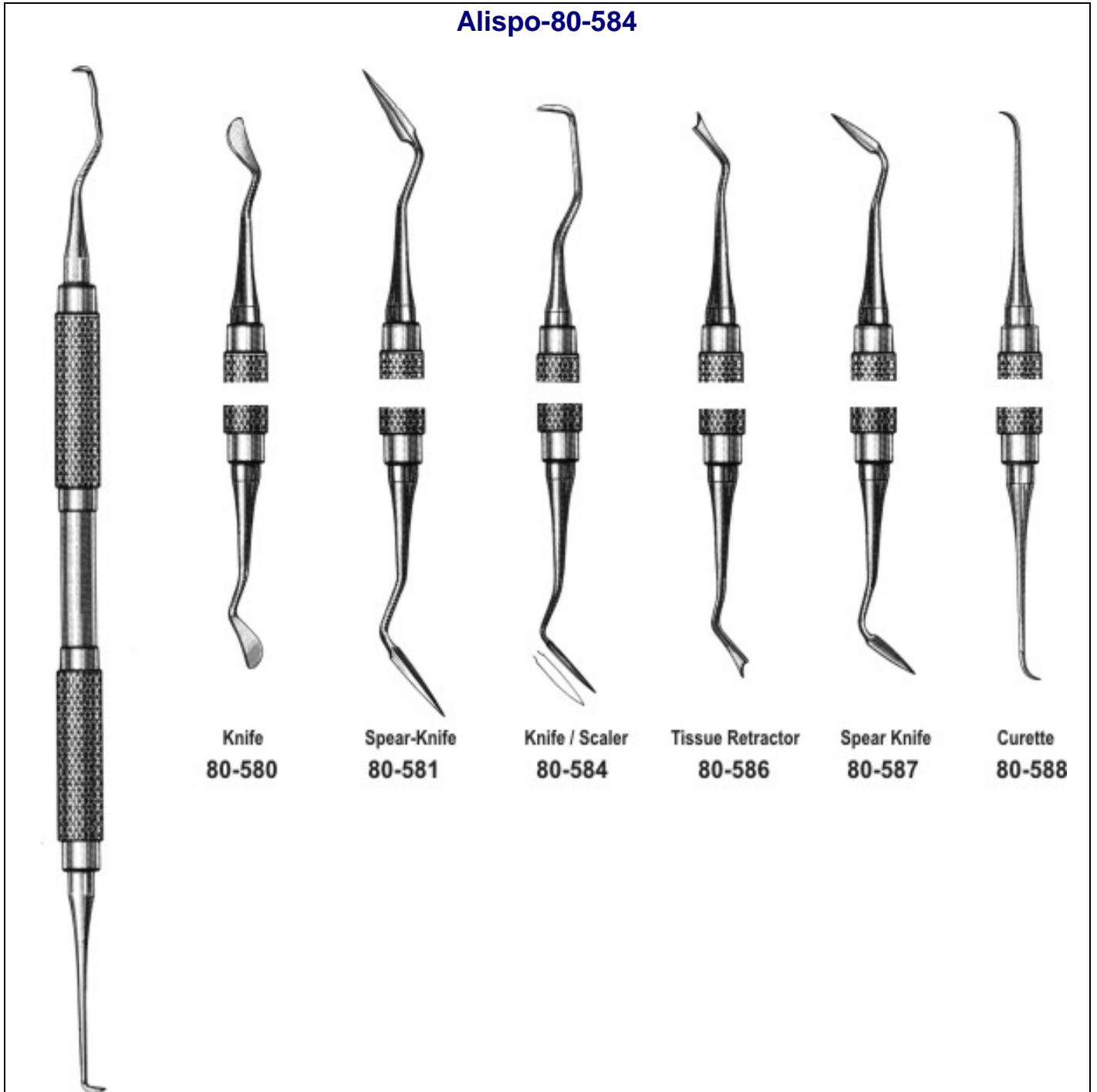

P.O. BOX-2872,

Roras Road' Muzaffar Pur' P.O. Small Industrial Estate' Sialkot "51310" Pakistan'

E-Mail: [info@alispo.com](mailto:info@alispo.com); [info@alispo.com.pk](mailto:info@alispo.com.pk) Web: [www.alispo.com](http://www.alispo.com); [www.alispo.com.pk](http://www.alispo.com.pk); [www.laparoscopysupplier.com](http://www.laparoscopysupplier.com)

Tel: +92-(0)-52-3 555674, 3254475 Fax: +92-(0)-52-3 556652, Cell: +92-(0)-300-8 717 212,



**Alispo** INTERNATIONAL

Manufacturers & Exporter of Surgical Instruments.

Tissue Retractor (Goldman-Fox)

**Alispo-80-586**

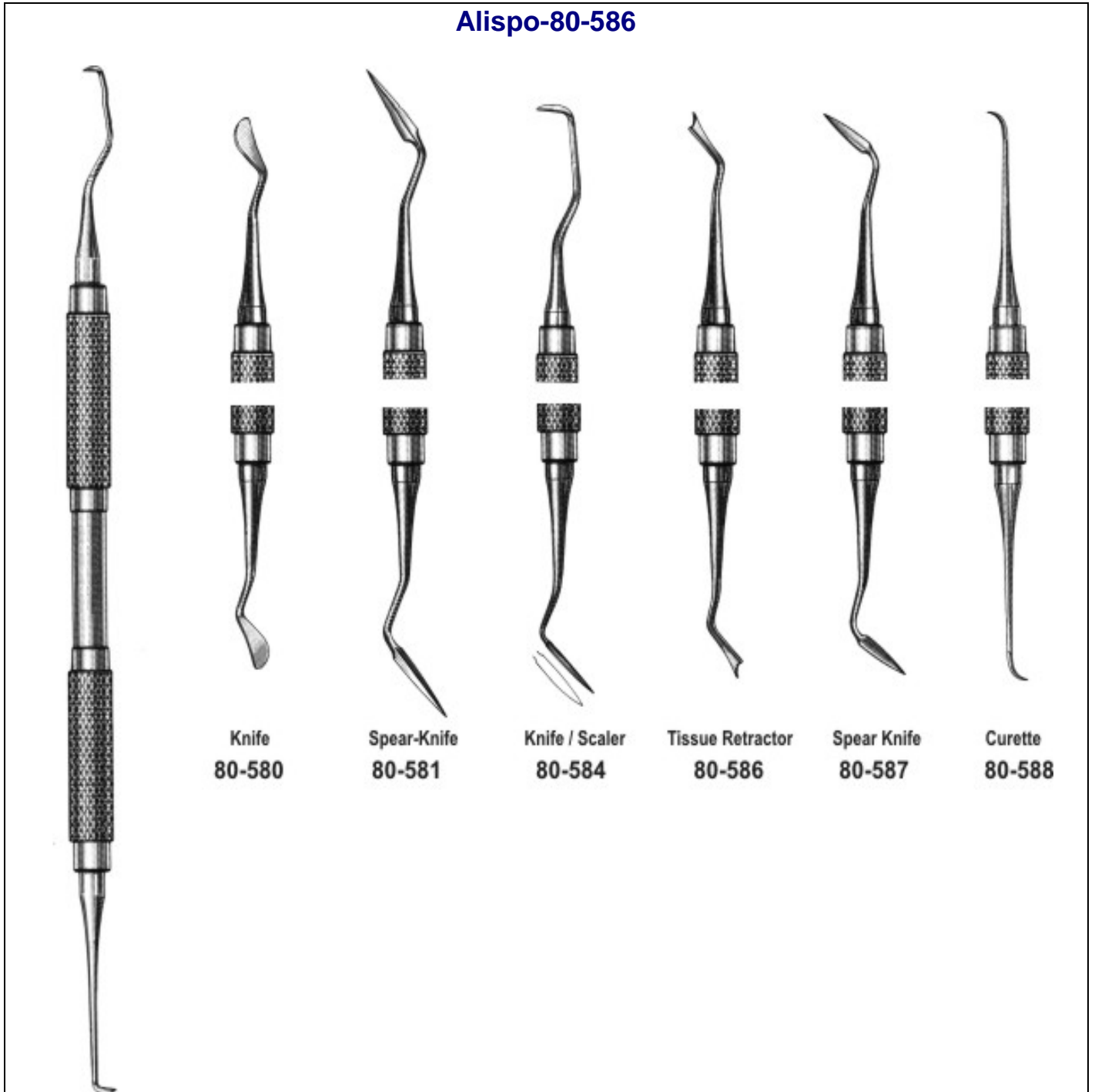

Knife  
80-580

Spear-Knife  
80-581

Knife / Scaler  
80-584

Tissue Retractor  
80-586

Spear Knife  
80-587

Curette  
80-588

P.O. BOX-2872,

Roras Road' Muzaffar Pur' P.O. Small Industrial Estate' Sialkot "51310" Pakistan'

E-Mail: [info@alispo.com](mailto:info@alispo.com); [info@alispo.com.pk](mailto:info@alispo.com.pk) Web: [www.alispo.com](http://www.alispo.com); [www.alispo.com.pk](http://www.alispo.com.pk); [www.laparoscopysupplier.com](http://www.laparoscopysupplier.com)

Tel: +92-(0)-52-3 555674, 3254475 Fax: +92-(0)-52-3 556652, Cell: +92-(0)-300-8 717 212,



**Alispo** INTERNATIONAL

Manufacturers & Exporter of Surgical Instruments.

Spear Knife (Goldman-Fox)

**Alispo-80-587**

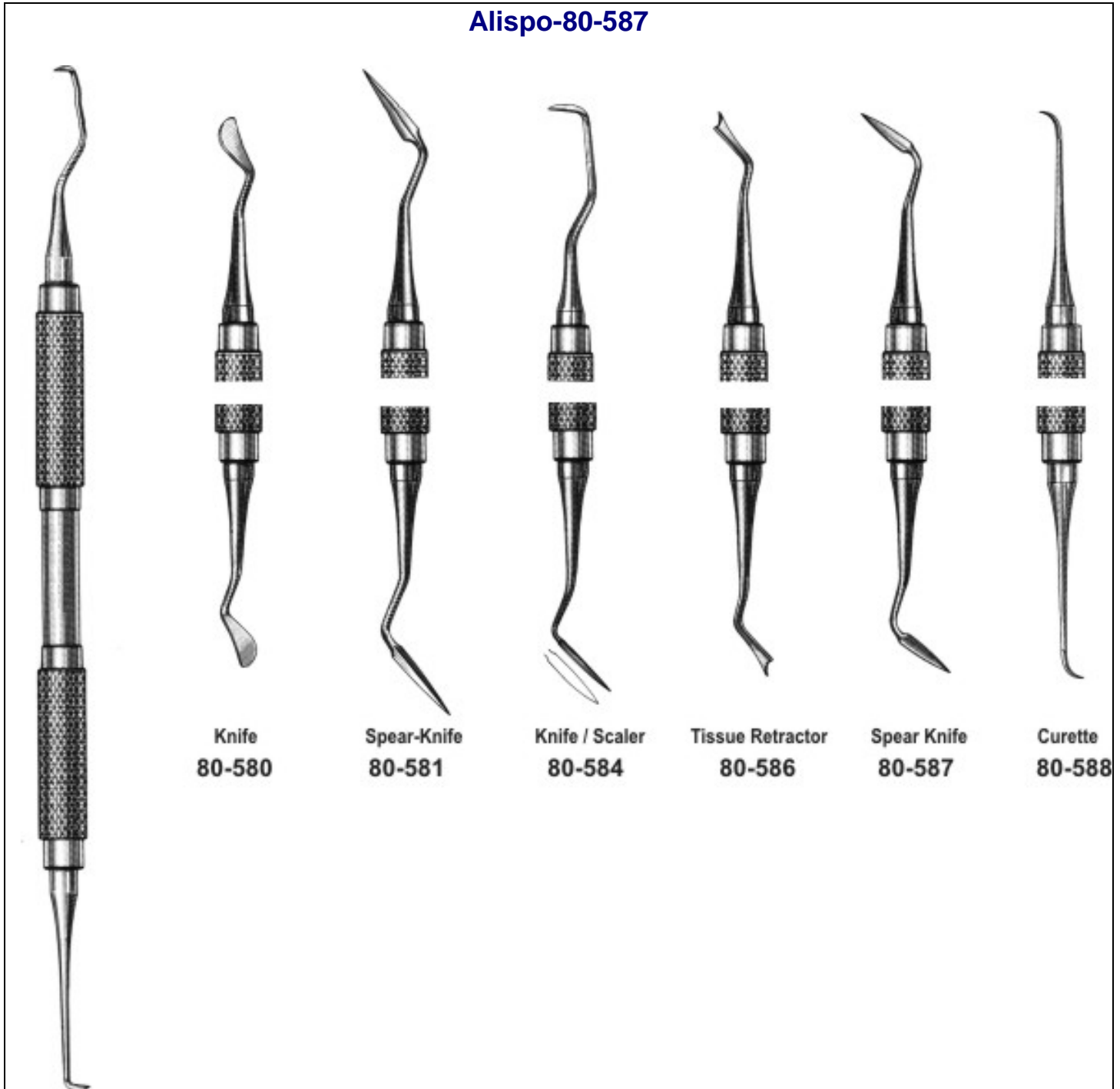

P.O. BOX-2872,

Roras Road' Muzaffar Pur' P.O. Small Industrial Estate' Sialkot "51310" Pakistan'

E-Mail: [info@alispo.com](mailto:info@alispo.com); [info@alispo.com.pk](mailto:info@alispo.com.pk) Web: [www.alispo.com](http://www.alispo.com); [www.alispo.com.pk](http://www.alispo.com.pk); [www.laparoscopysupplier.com](http://www.laparoscopysupplier.com)

Tel: +92-(0)-52-3 555674, 3254475 Fax: +92-(0)-52-3 556652, Cell: +92-(0)-300-8 717 212,



**Alispo** INTERNATIONAL

Manufacturers & Exporter of Surgical Instruments.

Curette (Goldman-Fox)

**Alispo-80-588**

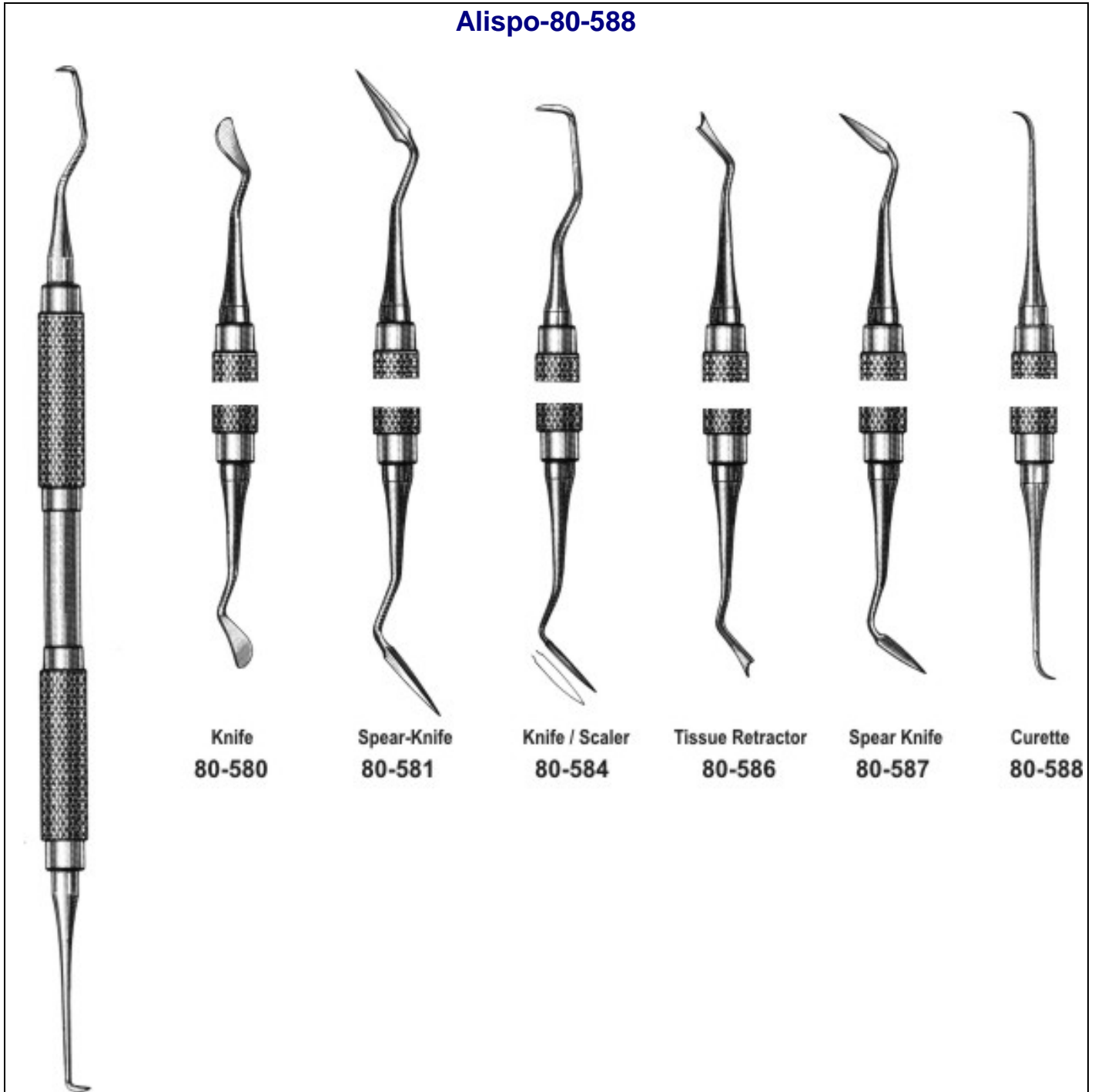

P.O. BOX-2872,

Roras Road' Muzaffar Pur' P.O. Small Industrial Estate' Sialkot "51310" Pakistan'

E-Mail: [info@alispo.com](mailto:info@alispo.com); [info@alispo.com.pk](mailto:info@alispo.com.pk) Web: [www.alispo.com](http://www.alispo.com); [www.alispo.com.pk](http://www.alispo.com.pk); [www.laparoscopysupplier.com](http://www.laparoscopysupplier.com)

Tel: +92-(0)-52-3 555674, 3254475 Fax: +92-(0)-52-3 556652, Cell: +92-(0)-300-8 717 212,



**Alispo** INTERNATIONAL

Manufacturers & Exporter of Surgical Instruments.

Dissector ( Crane-Kaplan)

**Alispo-80-601**

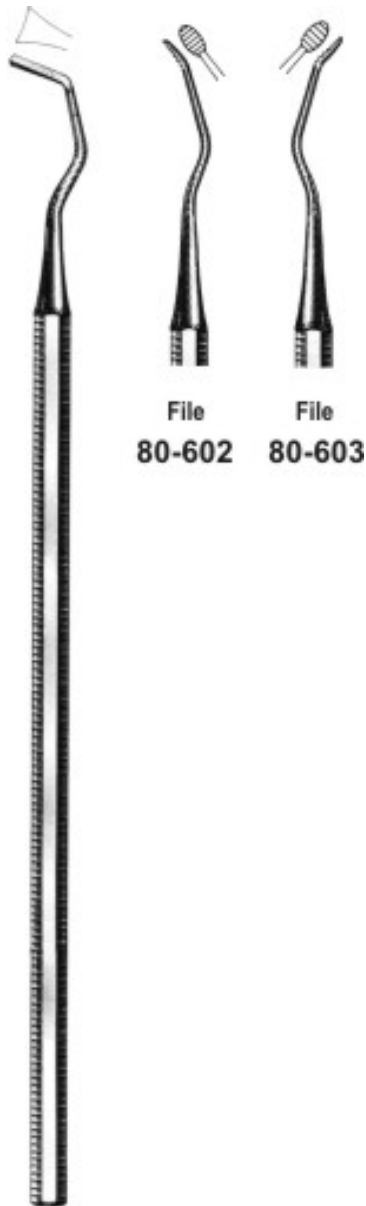

File  
**80-602**      File  
**80-603**

Dissector  
**80-601**



**Alispo** INTERNATIONAL

Manufacturers & Exporter of Surgical Instruments.

File ( Crane-Kaplan)

**Alispo-80-602**

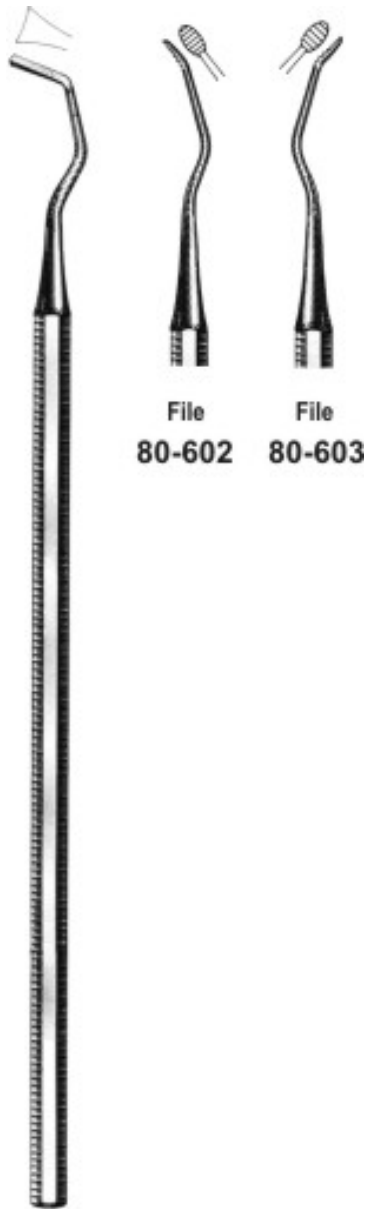

**Dissector  
80-601**

P.O. BOX-2872,

Roras Road' Muzaffar Pur' P.O. Small Industrial Estate' Sialkot "51310" Pakistan'

E-Mail: [info@alispo.com](mailto:info@alispo.com); [info@alispo.com.pk](mailto:info@alispo.com.pk) Web: [www.alispo.com](http://www.alispo.com); [www.alispo.com.pk](http://www.alispo.com.pk); [www.laparoscopysupplier.com](http://www.laparoscopysupplier.com)

Tel: +92-(0)-52-3 555674, 3254475 Fax: +92-(0)-52-3 556652, Cell: +92-(0)-300-8 717 212,



**Alispo** INTERNATIONAL

Manufacturers & Exporter of Surgical Instruments.

File (Crane-Kaplan)

**Alispo-80-603**

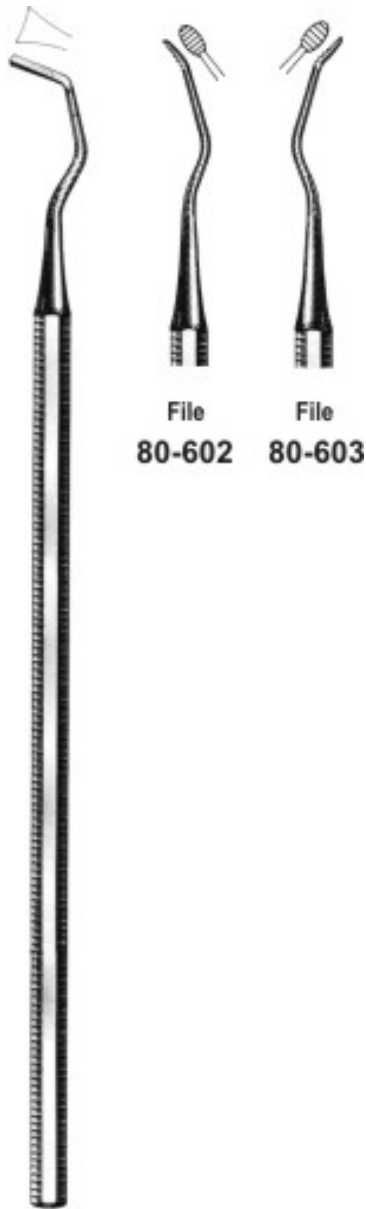

File  
80-602

File  
80-603

Dissector  
80-601



**Alispo** INTERNATIONAL

Manufacturers & Exporter of Surgical Instruments.

Knife (Crane-Kaplan)

**Alispo-80-605**



Knife  
**80-605**



**Alispo** INTERNATIONAL

Manufacturers & Exporter of Surgical Instruments.

Dissector (Crane-Kaplan)

**Alispo-80-608**

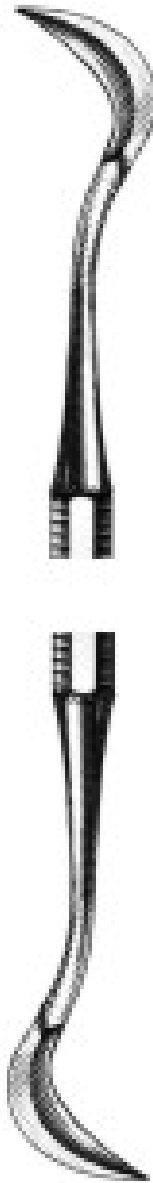

**Dissector  
80-608**



**Alispo** INTERNATIONAL

Manufacturers & Exporter of Surgical Instruments.

**Pocket Marker (Crane-Kaplan) # 1**

**Alispo-80-610**



**Pocket Marker  
80-611**

**Pocket Marker  
80-610**



**Alispo** INTERNATIONAL

Manufacturers & Exporter of Surgical Instruments.

**Pocket Marker (Crane-Kaplan) # 2**

**Alispo-80-611**



**Pocket Marker  
80-611**

**Pocket Marker  
80-610**



**Alispo** INTERNATIONAL

Manufacturers & Exporter of Surgical Instruments.

Orban Knife (Crane-Kaplan) # 1/2

**Alispo-80-615**



1 / 2  
Orban Knife  
**80-615**



**Alispo** INTERNATIONAL

Manufacturers & Exporter of Surgical Instruments.

Explorer 3CHD-L

**Alispo-80-618**

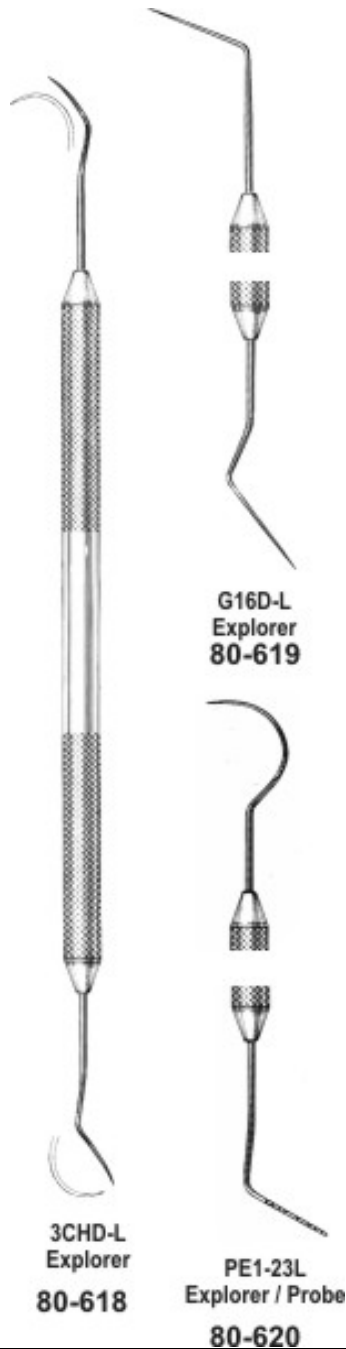

**3CHD-L  
Explorer  
80-618**

**G16D-L  
Explorer  
80-619**

**PE1-23L  
Explorer / Probe  
80-620**



**Alispo** INTERNATIONAL

Manufacturers & Exporter of Surgical Instruments.

Explorer G16D-L

**Alispo-80-619**

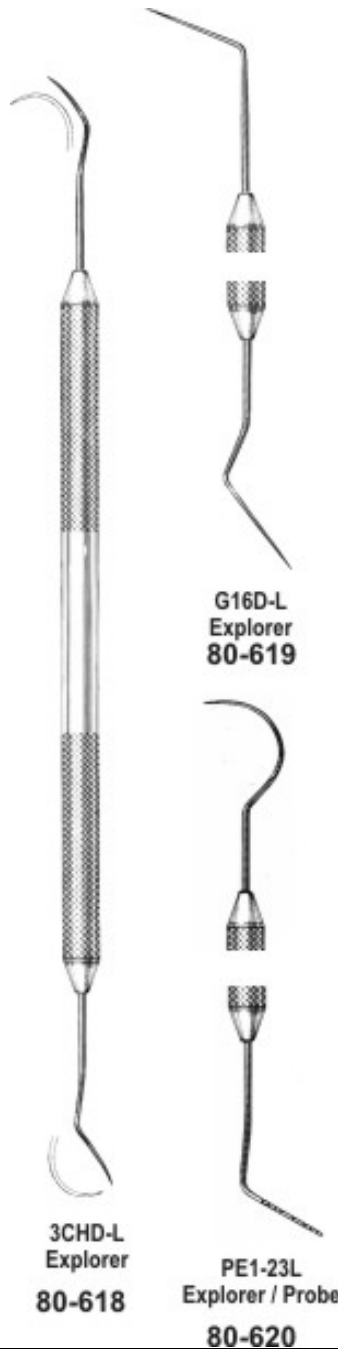

**3CHD-L  
Explorer  
80-618**

**G16D-L  
Explorer  
80-619**

**PE1-23L  
Explorer / Probe  
80-620**

P.O. BOX-2872,

Roras Road' Muzaffar Pur' P.O. Small Industrial Estate' Sialkot "51310" Pakistan'

E-Mail: [info@alispo.com](mailto:info@alispo.com); [info@alispo.com.pk](mailto:info@alispo.com.pk) Web: [www.alispo.com](http://www.alispo.com); [www.alispo.com.pk](http://www.alispo.com.pk); [www.laparoscopysupplier.com](http://www.laparoscopysupplier.com)

Tel: +92-(0)-52-3 555674, 3254475 Fax: +92-(0)-52-3 556652, Cell: +92-(0)-300-8 717 212,



**Alispo** INTERNATIONAL

Manufacturers & Exporter of Surgical Instruments.

Explorer/Probe PE1-23L

**Alispo-80-620**

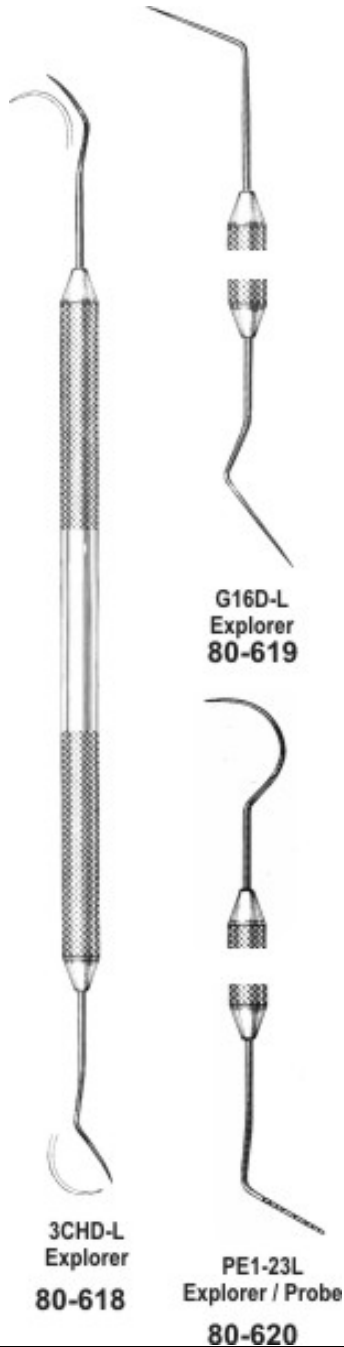

**3CHD-L  
Explorer  
80-618**

**G16D-L  
Explorer  
80-619**

**PE1-23L  
Explorer / Probe  
80-620**

P.O. BOX-2872,

Roras Road' Muzaffar Pur' P.O. Small Industrial Estate' Sialkot "51310" Pakistan'

E-Mail: [info@alispo.com](mailto:info@alispo.com); [info@alispo.com.pk](mailto:info@alispo.com.pk) Web: [www.alispo.com](http://www.alispo.com); [www.alispo.com.pk](http://www.alispo.com.pk); [www.laparoscopysupplier.com](http://www.laparoscopysupplier.com)

Tel: +92-(0)-52-3 555674, 3254475 Fax: +92-(0)-52-3 556652, Cell: +92-(0)-300-8 717 212,



**Alispo** INTERNATIONAL

Manufacturers & Exporter of Surgical Instruments.

Probe/Explorer GF 17

**Alispo-80-624**



GF17  
Probe / Explorer  
**80-624**

P.O. BOX-2872,

Roras Road' Muzaffar Pur' P.O. Small Industrial Estate' Sialkot "51310" Pakistan'

E-Mail: [info@alispo.com](mailto:info@alispo.com); [info@alispo.com.pk](mailto:info@alispo.com.pk) Web: [www.alispo.com](http://www.alispo.com); [www.alispo.com.pk](http://www.alispo.com.pk); [www.laparoscopysupplier.com](http://www.laparoscopysupplier.com)

Tel: +92-(0)-52-3 555674, 3254475 Fax: +92-(0)-52-3 556652, Cell: +92-(0)-300-8 717 212,



**Alispo** INTERNATIONAL

Manufacturers & Exporter of Surgical Instruments.

Probe GF18

**Alispo-80-630**



Gf18  
Probe

**80-630**



**Alispo** INTERNATIONAL

Manufacturers & Exporter of Surgical Instruments.

Explorer 23 S-L

**Alispo-80-637**



**23S-L  
Explorer  
80-637**



**Alispo** INTERNATIONAL

Manufacturers & Exporter of Surgical Instruments.

Probe C

**Alispo-80-641**

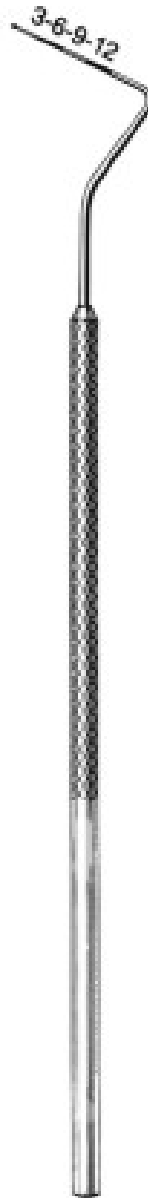

C  
Probe

**80-641**

P.O. BOX-2872,

Roras Road' Muzaffar Pur' P.O. Small Industrial Estate' Sialkot "51310" Pakistan'

E-Mail: [info@alispo.com](mailto:info@alispo.com); [info@alispo.com.pk](mailto:info@alispo.com.pk) Web: [www.alispo.com](http://www.alispo.com); [www.alispo.com.pk](http://www.alispo.com.pk); [www.laparoscopysupplier.com](http://www.laparoscopysupplier.com)

Tel: +92-(0)-52-3 555674, 3254475 Fax: +92-(0)-52-3 556652, Cell: +92-(0)-300-8 717 212,



**Alispo** INTERNATIONAL

Manufacturers & Exporter of Surgical Instruments.

Probe X2

**Alispo-80-645**



X2  
Probe

**80-645**



**Alispo** INTERNATIONAL

Manufacturers & Exporter of Surgical Instruments.

Excavator # 14

**Alispo-80-660**



**# 14  
80-660**



**# 17  
80-662**



**# 18  
80-663**



**# 19  
80-665**



**# 38 / 39  
80-670**



**# 61 / 62  
80-678**



# Alispo INTERNATIONAL

Manufacturers & Exporter of Surgical Instruments.

## Excavator # 17

### Alispo-80-662



# 14  
80-660



# 17  
80-662



# 18  
80-663



# 19  
80-665



# 38 / 39  
80-670



# 61 / 62  
80-678

P.O. BOX-2872,

Roras Road' Muzaffar Pur' P.O. Small Industrial Estate' Sialkot "51310" Pakistan'

E-Mail: [info@alispo.com](mailto:info@alispo.com); [info@alispo.com.pk](mailto:info@alispo.com.pk) Web: [www.alispo.com](http://www.alispo.com); [www.alispo.com.pk](http://www.alispo.com.pk); [www.laparoscopysupplier.com](http://www.laparoscopysupplier.com)

Tel: +92-(0)-52-3 555674, 3254475 Fax: +92-(0)-52-3 556652, Cell: +92-(0)-300-8 717 212,



**Alispo** INTERNATIONAL

Manufacturers & Exporter of Surgical Instruments.

Excavator # 18

**Alispo-80-663**



**# 14  
80-660**



**# 17  
80-662**



**# 18  
80-663**



**# 19  
80-665**



**# 38 / 39  
80-670**



**# 61 / 62  
80-678**

P.O. BOX-2872,

Roras Road' Muzaffar Pur' P.O. Small Industrial Estate' Sialkot "51310" Pakistan'

E-Mail: [info@alispo.com](mailto:info@alispo.com); [info@alispo.com.pk](mailto:info@alispo.com.pk) Web: [www.alispo.com](http://www.alispo.com); [www.alispo.com.pk](http://www.alispo.com.pk); [www.laparoscopysupplier.com](http://www.laparoscopysupplier.com)

Tel: +92-(0)-52-3 555674, 3254475 Fax: +92-(0)-52-3 556652, Cell: +92-(0)-300-8 717 212,



**Alispo** INTERNATIONAL

Manufacturers & Exporter of Surgical Instruments.

Excavator # 19

**Alispo-80-665**



**# 14  
80-660**



**# 17  
80-662**



**# 18  
80-663**



**# 19  
80-665**



**# 38 / 39  
80-670**



**# 61 / 62  
80-678**

P.O. BOX-2872,

Roras Road' Muzaffar Pur' P.O. Small Industrial Estate' Sialkot "51310" Pakistan'

E-Mail: [info@alispo.com](mailto:info@alispo.com); [info@alispo.com.pk](mailto:info@alispo.com.pk) Web: [www.alispo.com](http://www.alispo.com); [www.alispo.com.pk](http://www.alispo.com.pk); [www.laparoscopysupplier.com](http://www.laparoscopysupplier.com)

Tel: +92-(0)-52-3 555674, 3254475 Fax: +92-(0)-52-3 556652, Cell: +92-(0)-300-8 717 212,



# Alispo INTERNATIONAL

Manufacturers & Exporter of Surgical Instruments.

## Excavator # 38/39

### Alispo-80-670



**# 14**  
**80-660**



**# 17**  
**80-662**



**# 18**  
**80-663**



**# 19**  
**80-665**



**# 38 / 39**  
**80-670**



**# 61 / 62**  
**80-678**

P.O. BOX-2872,

Roras Road' Muzaffar Pur' P.O. Small Industrial Estate' Sialkot "51310" Pakistan'

E-Mail: [info@alispo.com](mailto:info@alispo.com); [info@alispo.com.pk](mailto:info@alispo.com.pk) Web: [www.alispo.com](http://www.alispo.com); [www.alispo.com.pk](http://www.alispo.com.pk); [www.laparoscopysupplier.com](http://www.laparoscopysupplier.com)

Tel: +92-(0)-52-3 555674, 3254475 Fax: +92-(0)-52-3 556652, Cell: +92-(0)-300-8 717 212,



# Alispo INTERNATIONAL

Manufacturers & Exporter of Surgical Instruments.

## Excavator # 61/62

### Alispo-80-678



# 14  
80-660



# 17  
80-662



# 18  
80-663



# 19  
80-665



# 38 / 39  
80-670



# 61 / 62  
80-678

P.O. BOX-2872,

Roras Road' Muzaffar Pur' P.O. Small Industrial Estate' Sialkot "51310" Pakistan'

E-Mail: [info@alispo.com](mailto:info@alispo.com); [info@alispo.com.pk](mailto:info@alispo.com.pk) Web: [www.alispo.com](http://www.alispo.com); [www.alispo.com.pk](http://www.alispo.com.pk); [www.laparoscopysupplier.com](http://www.laparoscopysupplier.com)

Tel: +92-(0)-52-3 555674, 3254475 Fax: +92-(0)-52-3 556652, Cell: +92-(0)-300-8 717 212,



**Alispo** INTERNATIONAL

Manufacturers & Exporter of Surgical Instruments.

Excavator # 31 L

**Alispo-80-680**

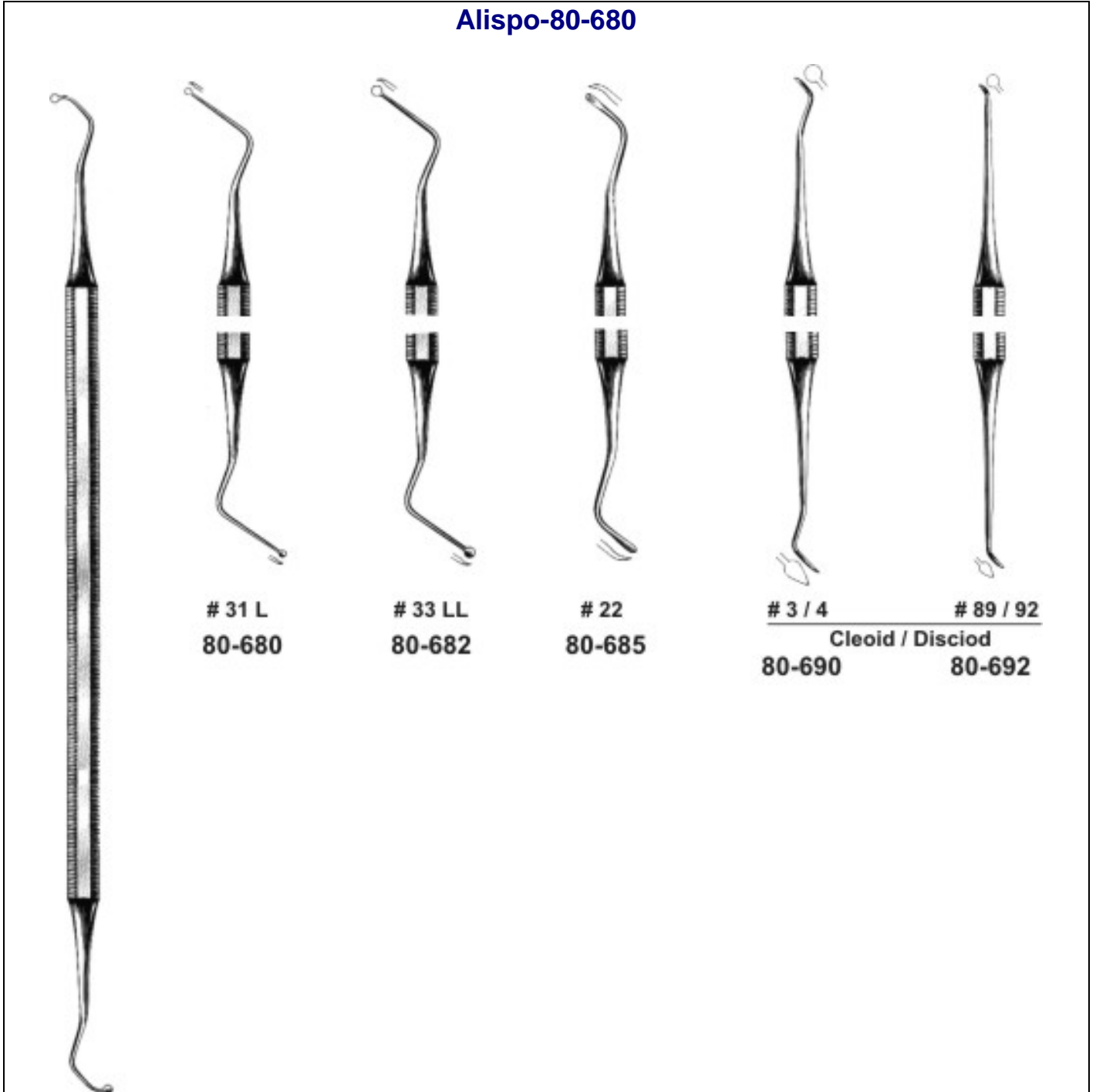

P.O. BOX-2872,

Roras Road' Muzaffar Pur' P.O. Small Industrial Estate' Sialkot "51310" Pakistan'

E-Mail: [info@alispo.com](mailto:info@alispo.com); [info@alispo.com.pk](mailto:info@alispo.com.pk) Web: [www.alispo.com](http://www.alispo.com); [www.alispo.com.pk](http://www.alispo.com.pk); [www.laparoscopysupplier.com](http://www.laparoscopysupplier.com)

Tel: +92-(0)-52-3 555674, 3254475 Fax: +92-(0)-52-3 556652, Cell: +92-(0)-300-8 717 212,



# Alispo INTERNATIONAL

Manufacturers & Exporter of Surgical Instruments.

## Excavator # 33 L

### Alispo-80-682

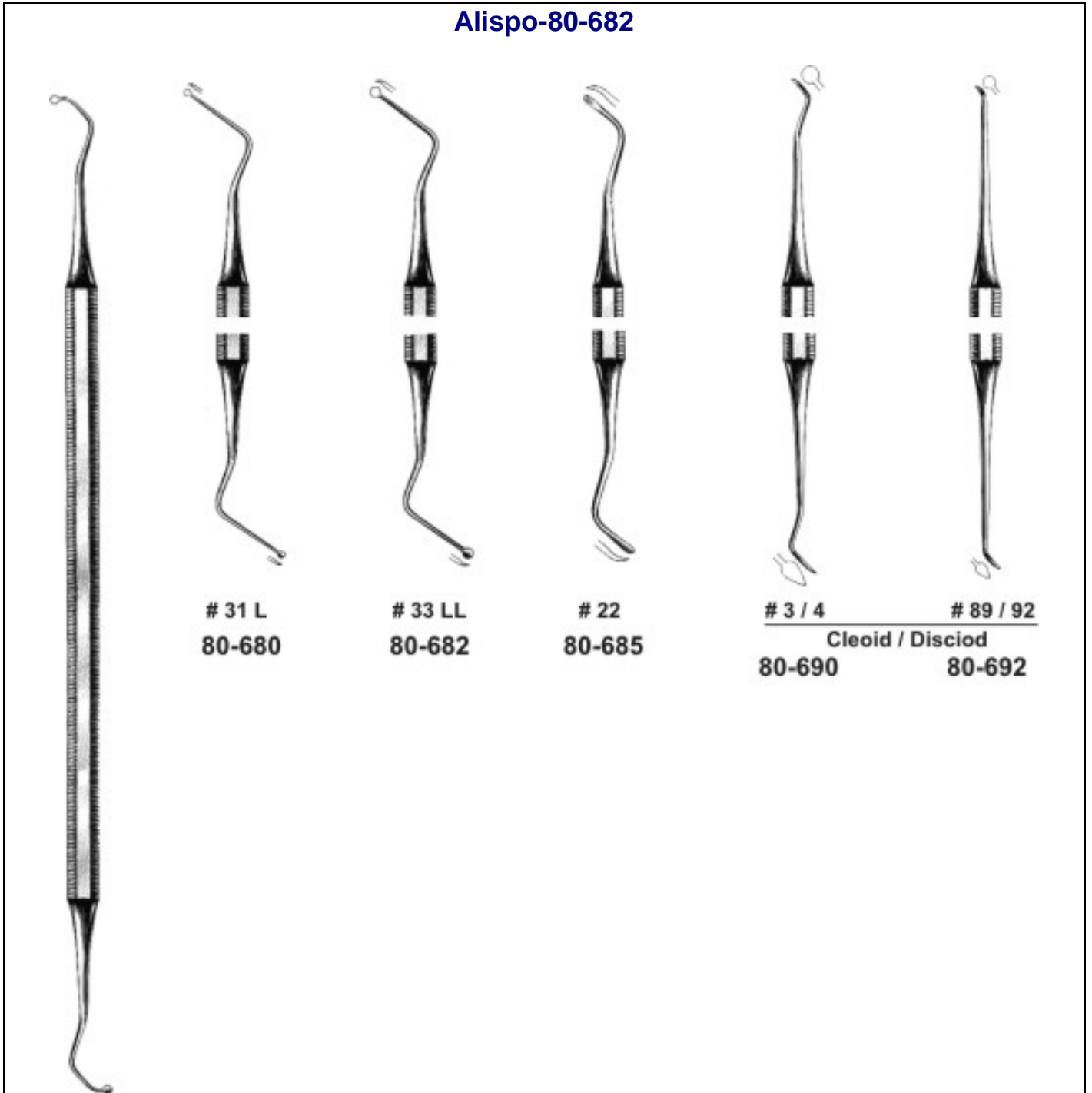

P.O. BOX-2872,

Roras Road' Muzaffar Pur' P.O. Small Industrial Estate' Sialkot "51310" Pakistan'

E-Mail: [info@alispo.com](mailto:info@alispo.com); [info@alispo.com.pk](mailto:info@alispo.com.pk) Web: [www.alispo.com](http://www.alispo.com); [www.alispo.com.pk](http://www.alispo.com.pk); [www.laparoscopysupplier.com](http://www.laparoscopysupplier.com)

Tel: +92-(0)-52-3 555674, 3254475 Fax: +92-(0)-52-3 556652, Cell: +92-(0)-300-8 717 212,



# Alispo INTERNATIONAL

Manufacturers & Exporter of Surgical Instruments.

## Excavator # 22

### Alispo-80-685

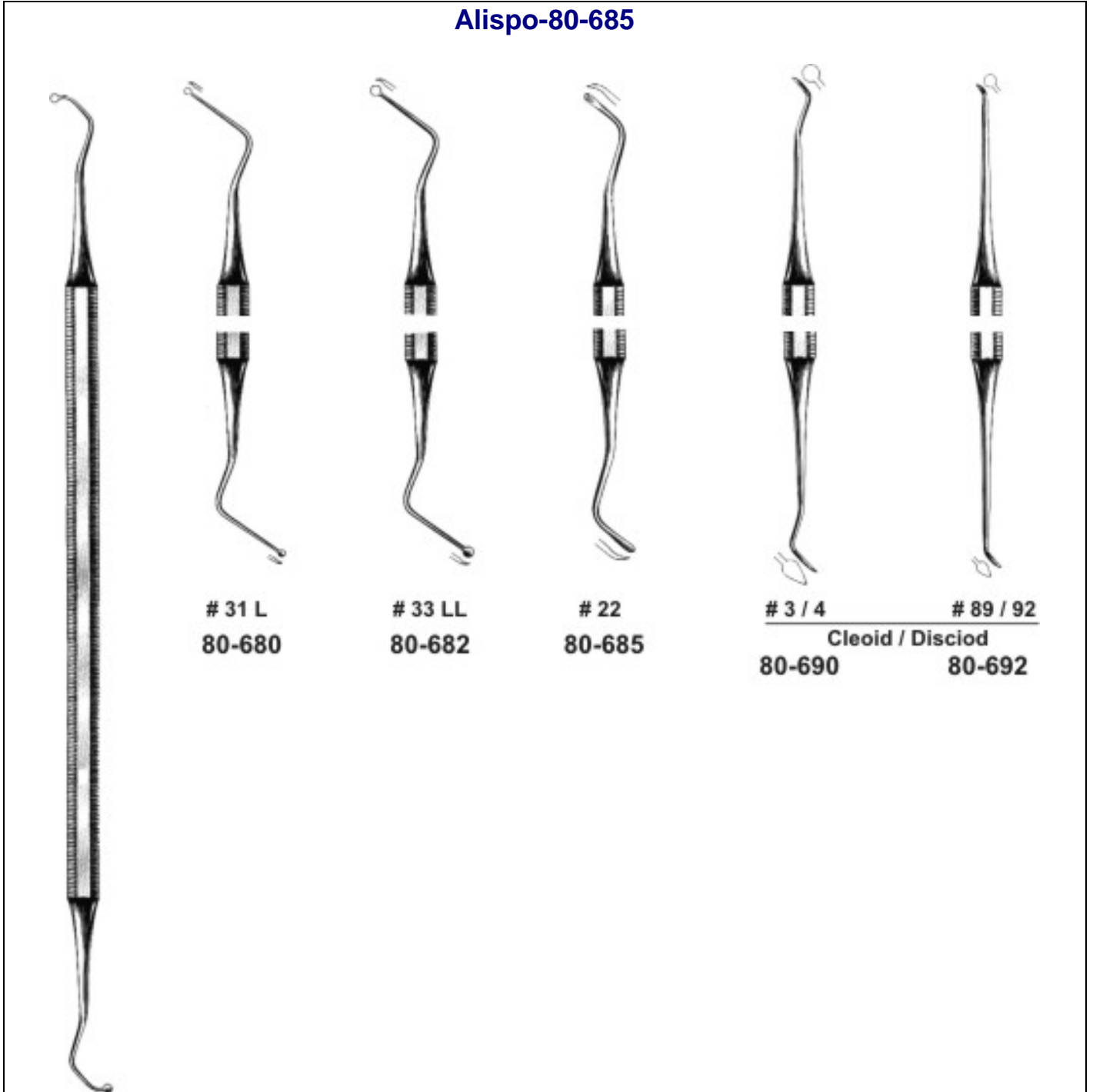

P.O. BOX-2872,

Roras Road' Muzaffar Pur' P.O. Small Industrial Estate' Sialkot "51310" Pakistan'

E-Mail: [info@alispo.com](mailto:info@alispo.com); [info@alispo.com.pk](mailto:info@alispo.com.pk) Web: [www.alispo.com](http://www.alispo.com); [www.alispo.com.pk](http://www.alispo.com.pk); [www.laparoscopysupplier.com](http://www.laparoscopysupplier.com)

Tel: +92-(0)-52-3 555674, 3254475 Fax: +92-(0)-52-3 556652, Cell: +92-(0)-300-8 717 212,



**Alispo** INTERNATIONAL

Manufacturers & Exporter of Surgical Instruments.

Excavator (Cleoid/Disciod) # 3/4

**Alispo-80-690**

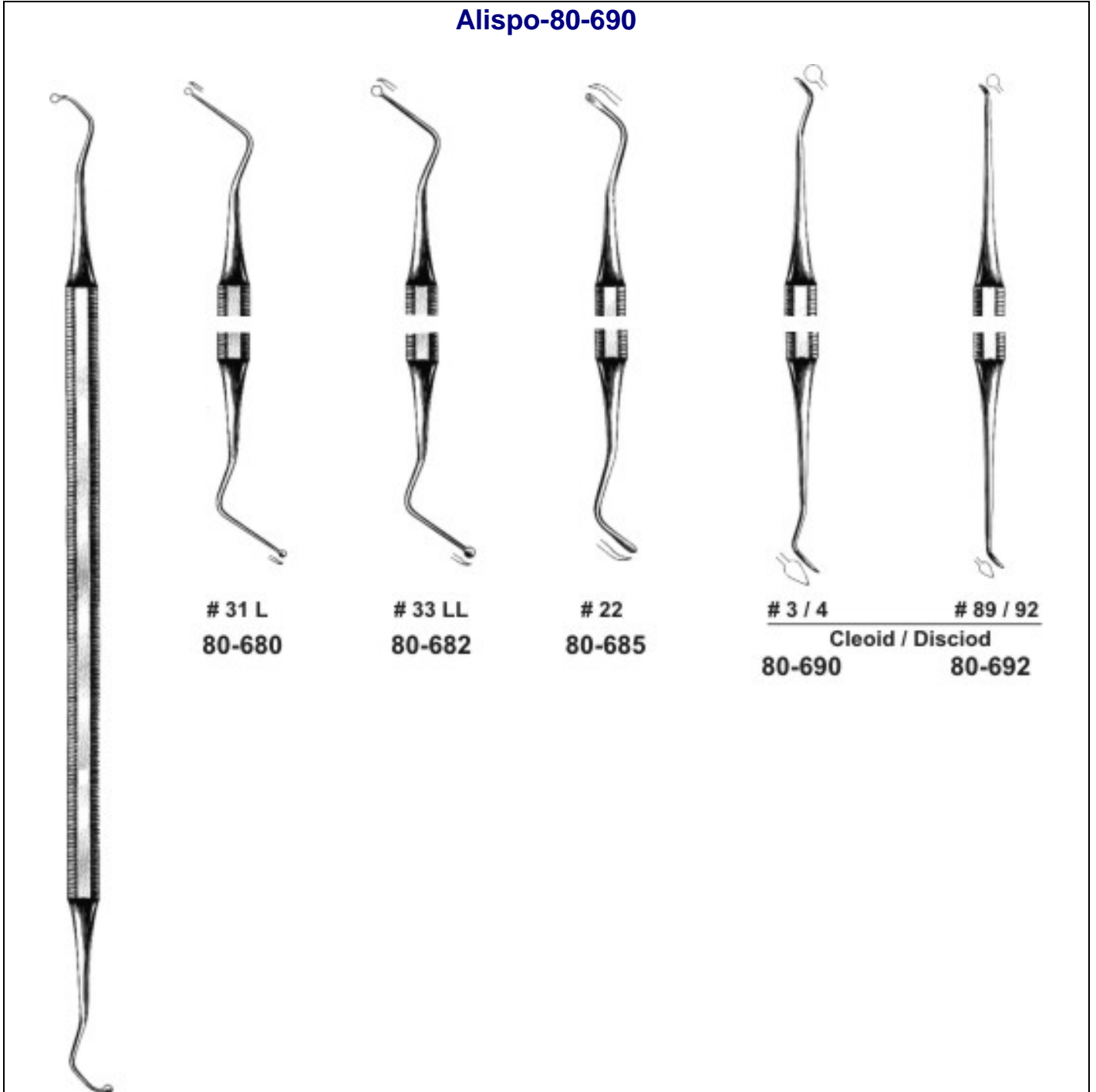

P.O. BOX-2872,

Roras Road' Muzaffar Pur' P.O. Small Industrial Estate' Sialkot "51310" Pakistan'

E-Mail: [info@alispo.com](mailto:info@alispo.com); [info@alispo.com.pk](mailto:info@alispo.com.pk) Web: [www.alispo.com](http://www.alispo.com); [www.alispo.com.pk](http://www.alispo.com.pk); [www.laparoscopysupplier.com](http://www.laparoscopysupplier.com)

Tel: +92-(0)-52-3 555674, 3254475 Fax: +92-(0)-52-3 556652, Cell: +92-(0)-300-8 717 212,



**Alispo** INTERNATIONAL

Manufacturers & Exporter of Surgical Instruments.

Excavator (Cleoid/Disciod) # 89/92

**Alispo-80-692**

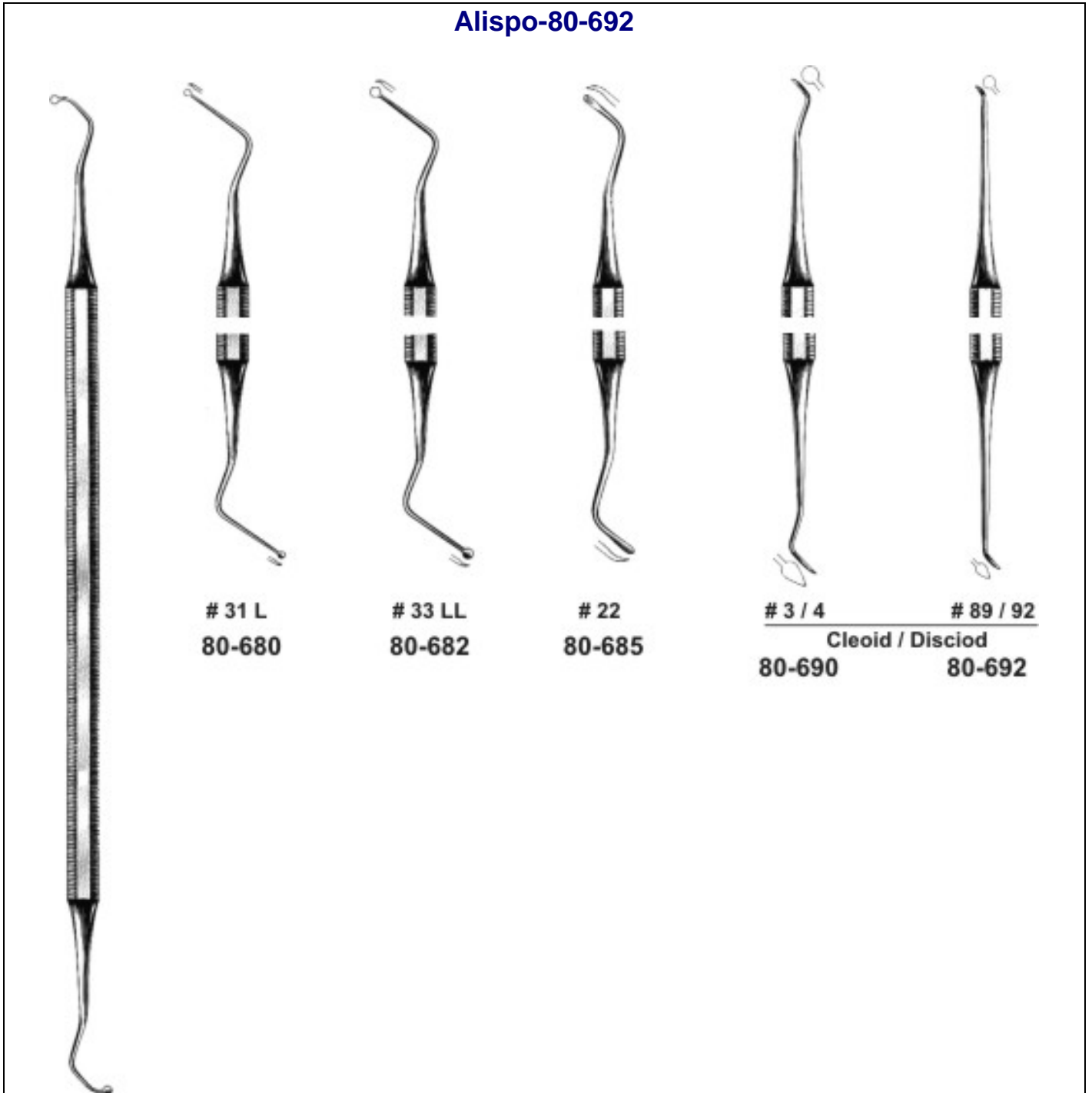

P.O. BOX-2872,

Roras Road' Muzaffar Pur' P.O. Small Industrial Estate' Sialkot "51310" Pakistan'

E-Mail: [info@alispo.com](mailto:info@alispo.com); [info@alispo.com.pk](mailto:info@alispo.com.pk) Web: [www.alispo.com](http://www.alispo.com); [www.alispo.com.pk](http://www.alispo.com.pk); [www.laparoscopysupplier.com](http://www.laparoscopysupplier.com)

Tel: +92-(0)-52-3 555674, 3254475 Fax: +92-(0)-52-3 556652, Cell: +92-(0)-300-8 717 212,



**Alispo** INTERNATIONAL

Manufacturers & Exporter of Surgical Instruments.

Filling Instrument # 3

**Alispo-80-695**

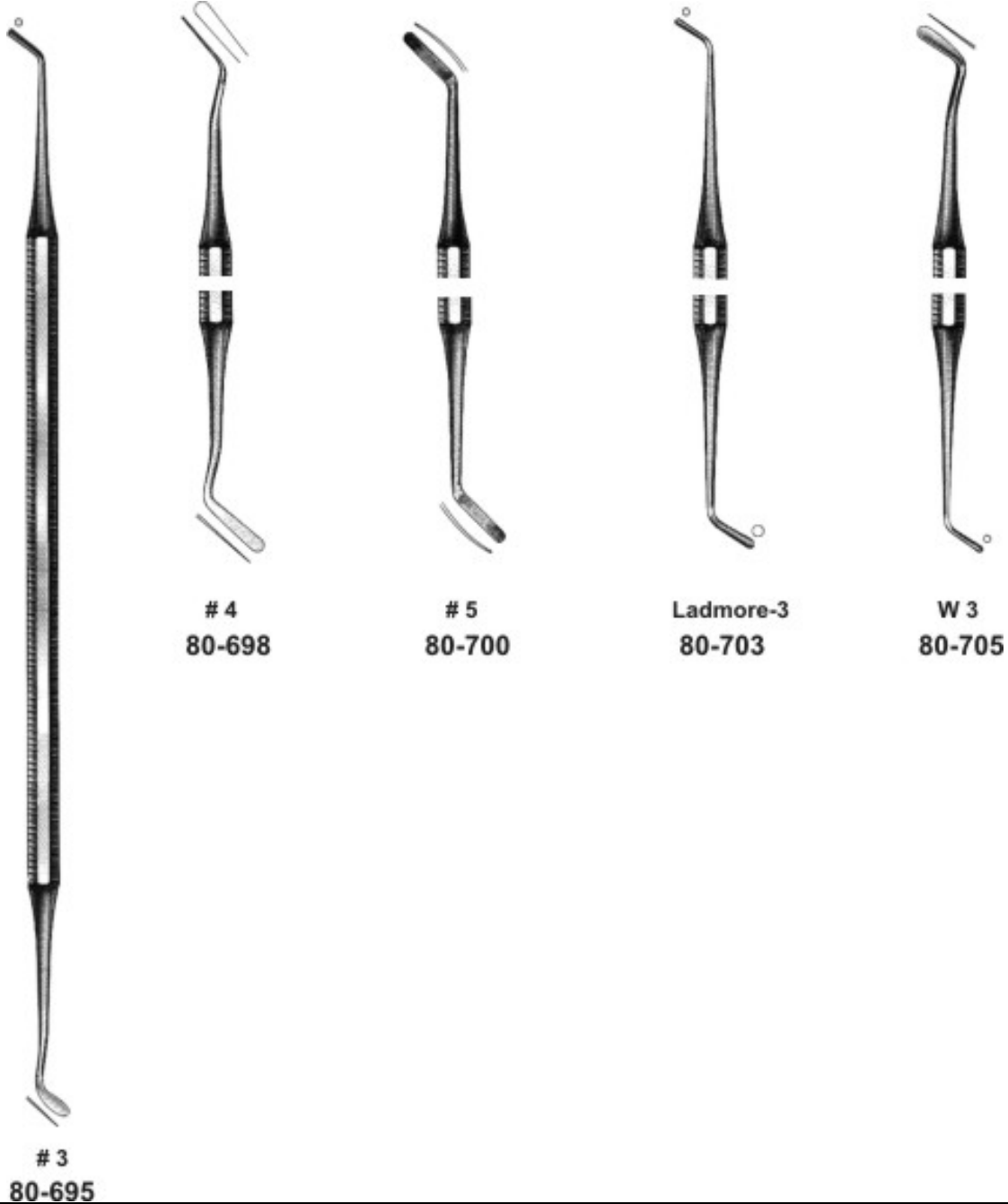

P.O. BOX-2872,

Roras Road' Muzaffar Pur' P.O. Small Industrial Estate' Sialkot "51310" Pakistan'

E-Mail: [info@alispo.com](mailto:info@alispo.com); [info@alispo.com.pk](mailto:info@alispo.com.pk) Web: [www.alispo.com](http://www.alispo.com); [www.alispo.com.pk](http://www.alispo.com.pk); [www.laparoscopysupplier.com](http://www.laparoscopysupplier.com)

Tel: +92-(0)-52-3 555674, 3254475 Fax: +92-(0)-52-3 556652, Cell: +92-(0)-300-8 717 212,



**Alispo** INTERNATIONAL

Manufacturers & Exporter of Surgical Instruments.

Filling Instrument # 4

**Alispo-80-698**

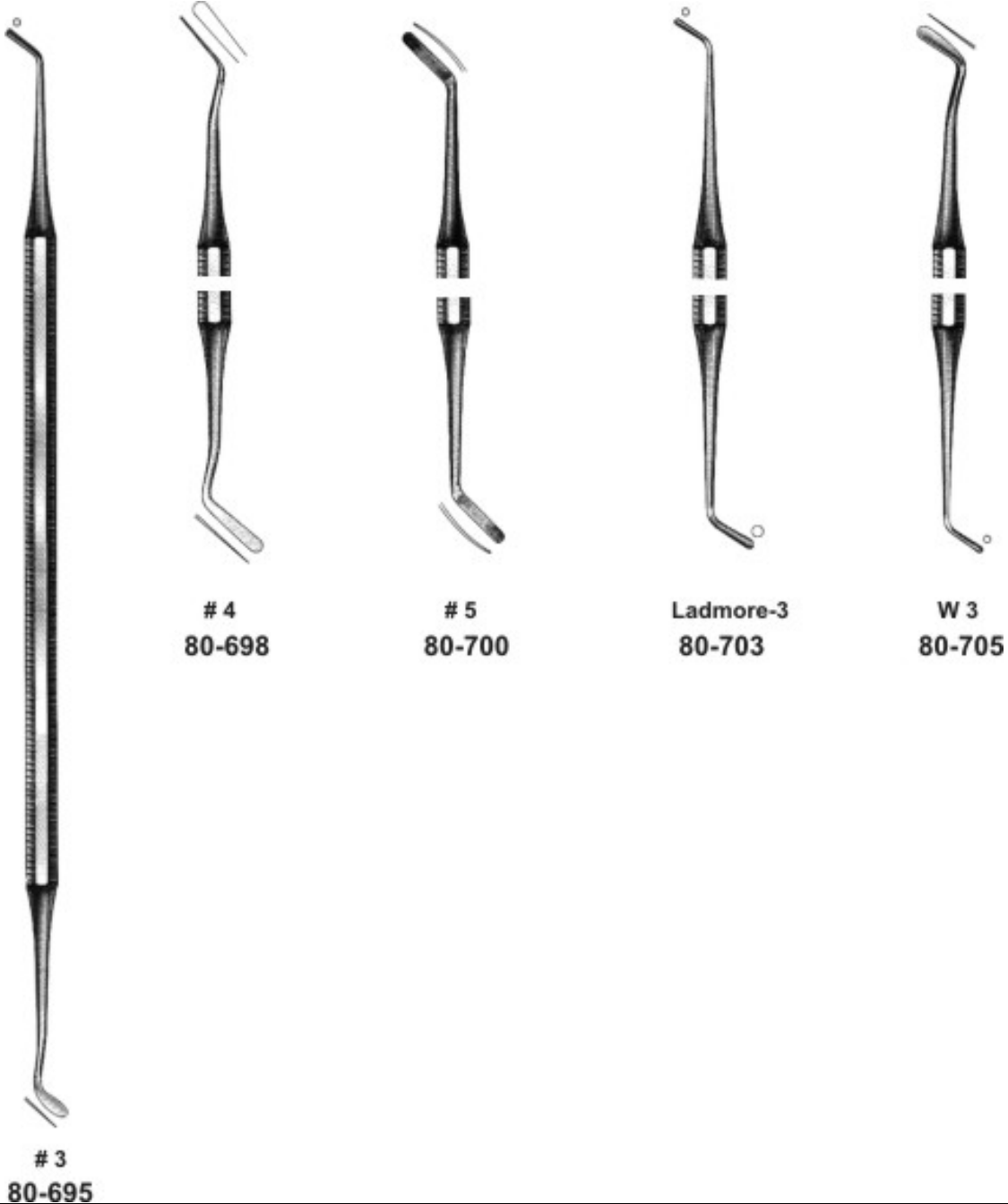



**Alispo** INTERNATIONAL

Manufacturers & Exporter of Surgical Instruments.

Filling Instrument # 5

**Alispo-80-700**

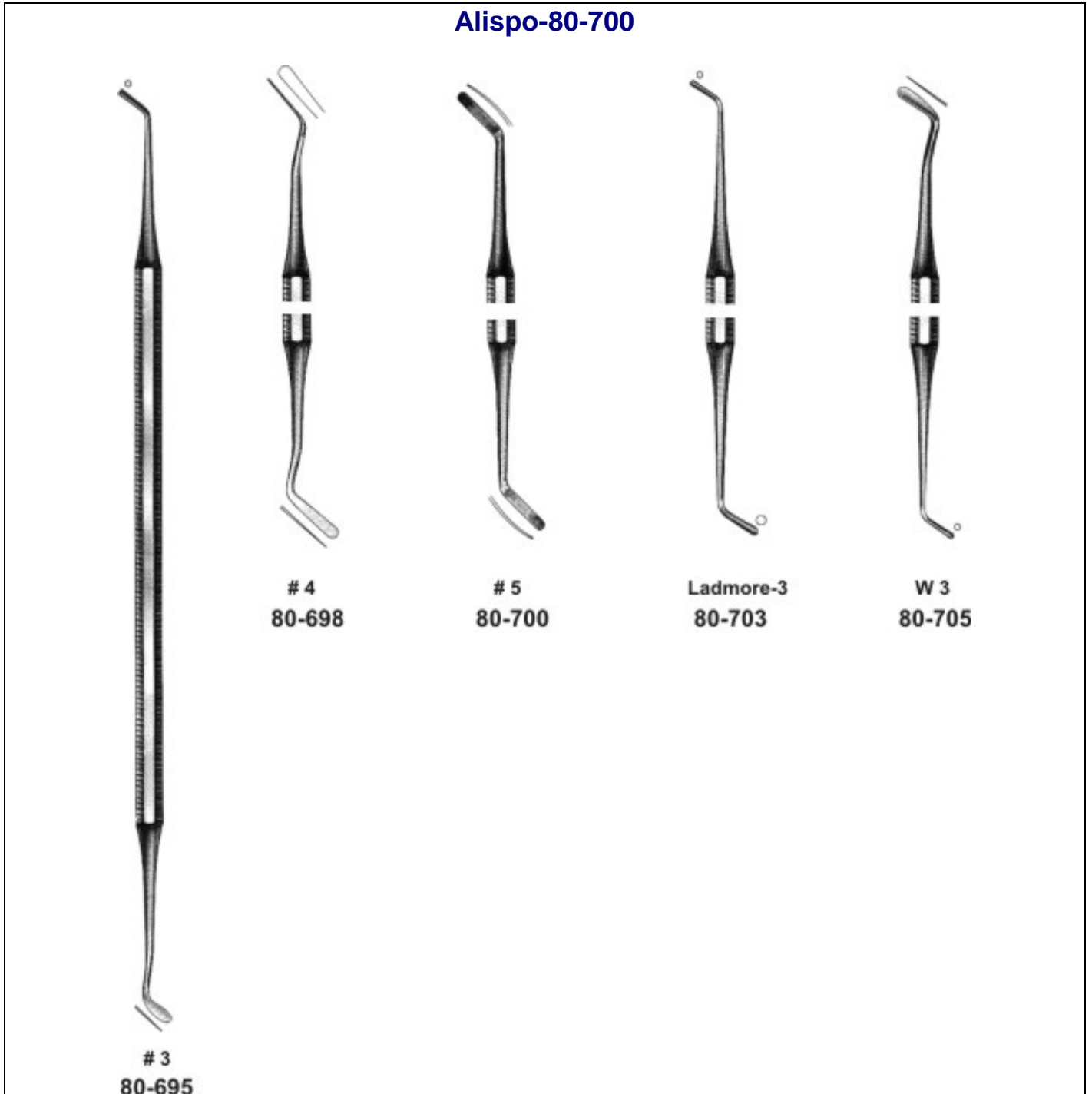

P.O. BOX-2872,

Roras Road' Muzaffar Pur' P.O. Small Industrial Estate' Sialkot "51310" Pakistan'

E-Mail: [info@alispo.com](mailto:info@alispo.com); [info@alispo.com.pk](mailto:info@alispo.com.pk) Web: [www.alispo.com](http://www.alispo.com); [www.alispo.com.pk](http://www.alispo.com.pk); [www.laparoscopysupplier.com](http://www.laparoscopysupplier.com)

Tel: +92-(0)-52-3 555674, 3254475 Fax: +92-(0)-52-3 556652, Cell: +92-(0)-300-8 717 212,



**Alispo** INTERNATIONAL

Manufacturers & Exporter of Surgical Instruments.

Filling Instrument Ladmore-3

**Alispo-80-703**

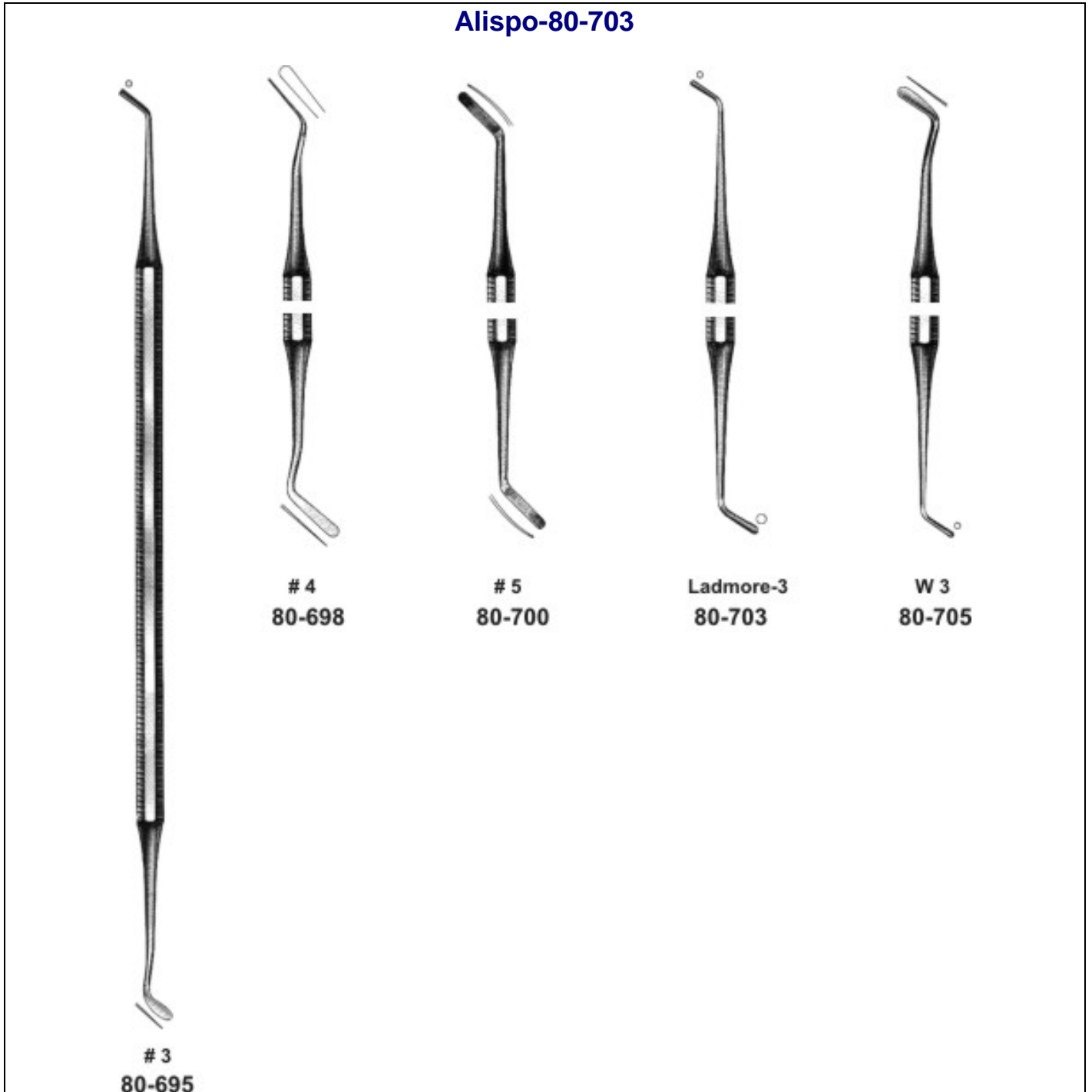

P.O. BOX-2872,

Roras Road' Muzaffar Pur' P.O. Small Industrial Estate' Sialkot "51310" Pakistan'

E-Mail: [info@alispo.com](mailto:info@alispo.com); [info@alispo.com.pk](mailto:info@alispo.com.pk) Web: [www.alispo.com](http://www.alispo.com); [www.alispo.com.pk](http://www.alispo.com.pk); [www.laparoscopysupplier.com](http://www.laparoscopysupplier.com)

Tel: +92-(0)-52-3 555674, 3254475 Fax: +92-(0)-52-3 556652, Cell: +92-(0)-300-8 717 212,



**Alispo** INTERNATIONAL

Manufacturers & Exporter of Surgical Instruments.

Filling Instrument # W3

**Alispo-80-705**

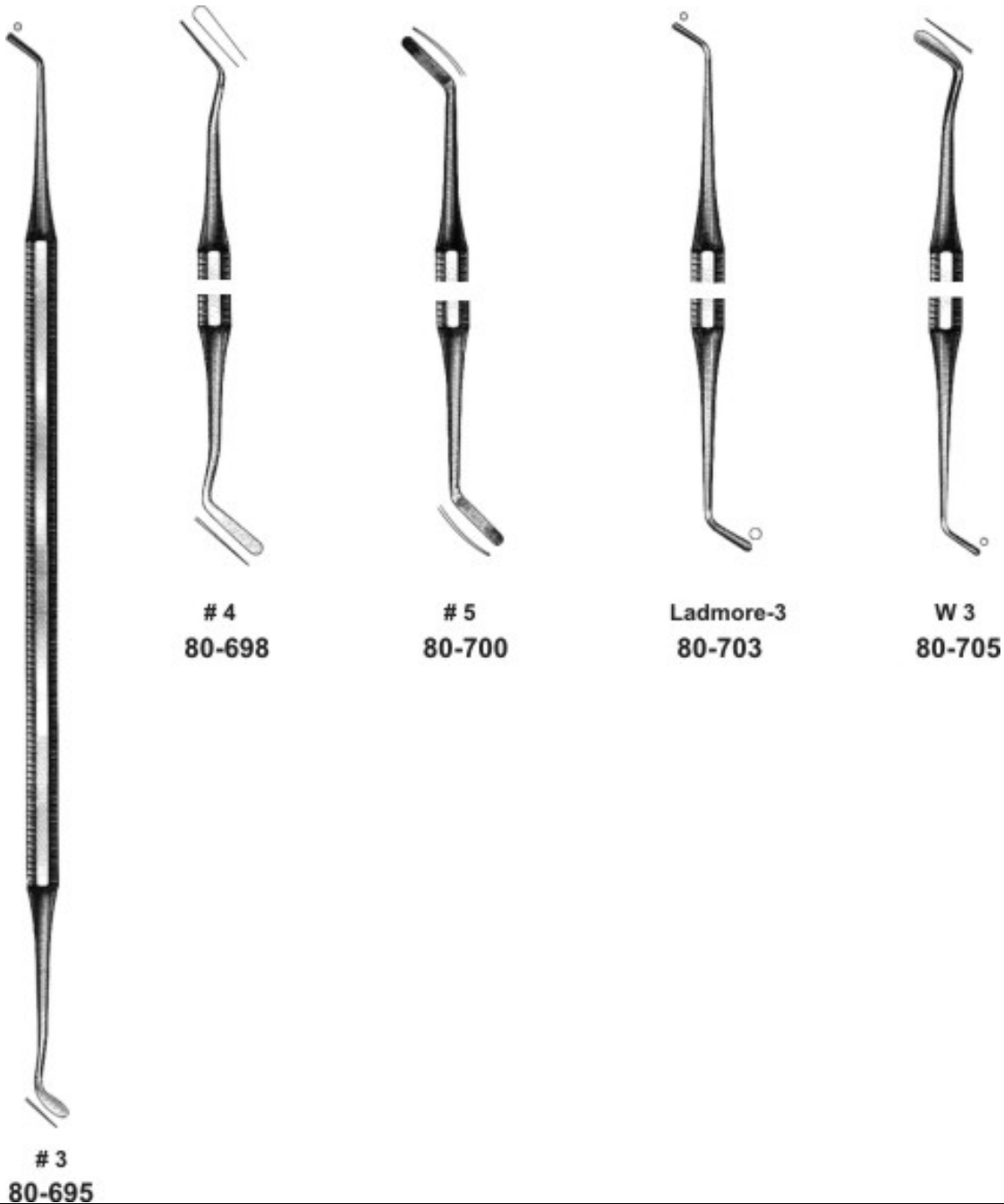



**Alispo** INTERNATIONAL

Manufacturers & Exporter of Surgical Instruments.

Filling Instrument #1

**Alispo-80-708**

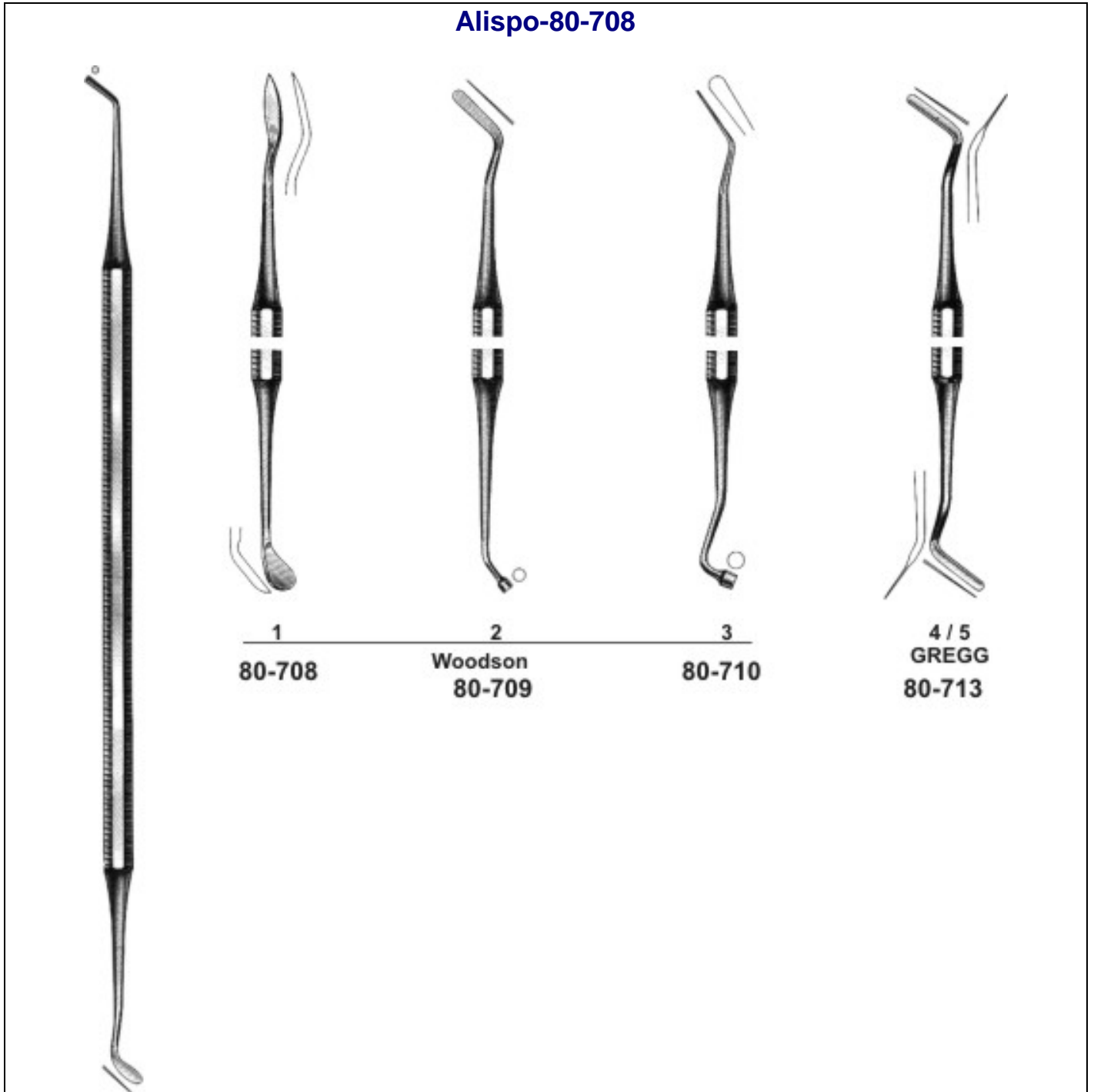

P.O. BOX-2872,

Roras Road' Muzaffar Pur' P.O. Small Industrial Estate' Sialkot "51310" Pakistan'

E-Mail: [info@alispo.com](mailto:info@alispo.com); [info@alispo.com.pk](mailto:info@alispo.com.pk) Web: [www.alispo.com](http://www.alispo.com); [www.alispo.com.pk](http://www.alispo.com.pk); [www.laparoscopysupplier.com](http://www.laparoscopysupplier.com)

Tel: +92-(0)-52-3 555674, 3254475 Fax: +92-(0)-52-3 556652, Cell: +92-(0)-300-8 717 212,



**Alispo** INTERNATIONAL

Manufacturers & Exporter of Surgical Instruments.

Filling Instrument # 2

**Alispo-80-709**

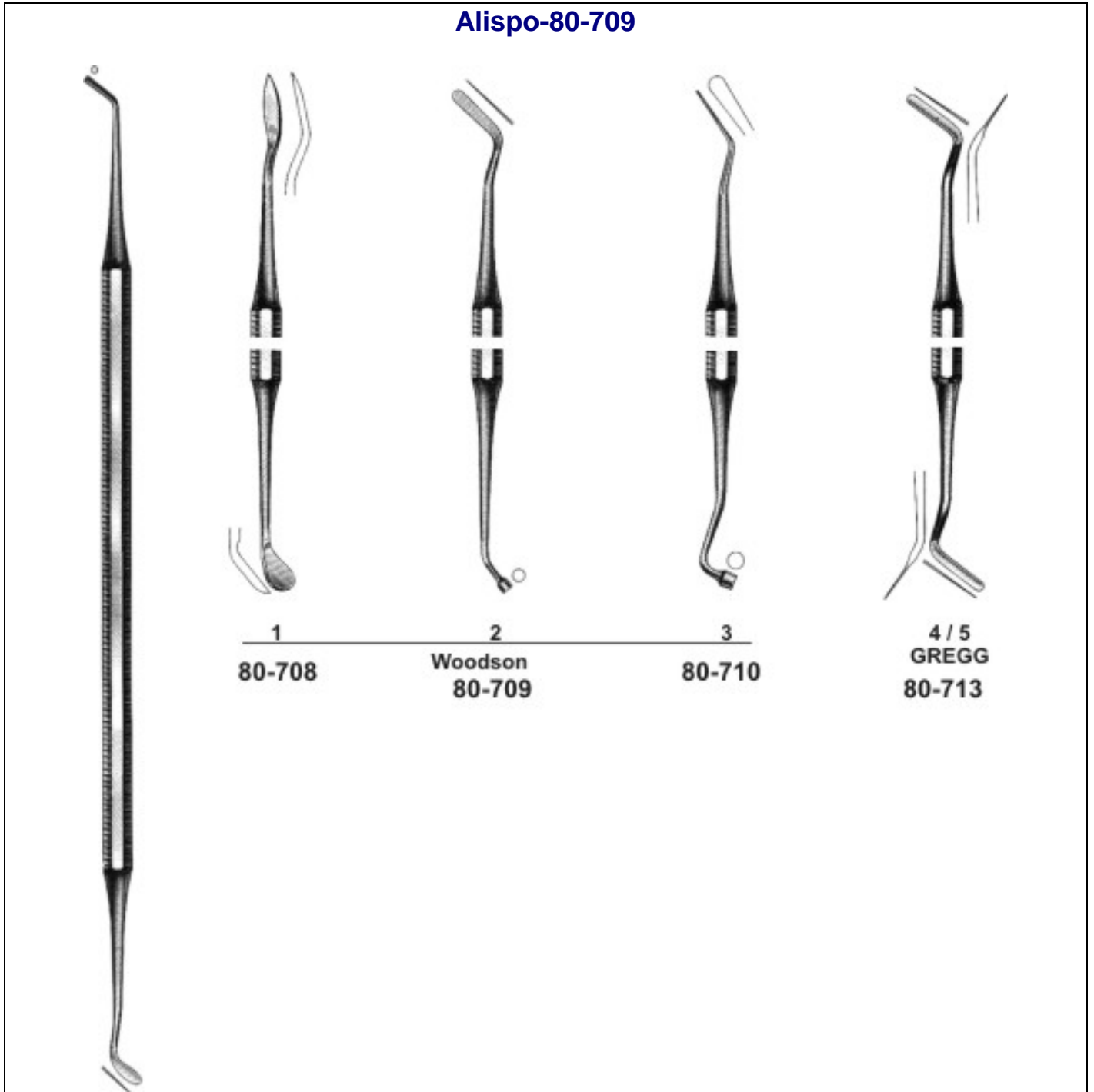

P.O. BOX-2872,

Roras Road' Muzaffar Pur' P.O. Small Industrial Estate' Sialkot "51310" Pakistan'

E-Mail: [info@alispo.com](mailto:info@alispo.com); [info@alispo.com.pk](mailto:info@alispo.com.pk) Web: [www.alispo.com](http://www.alispo.com); [www.alispo.com.pk](http://www.alispo.com.pk); [www.laparoscopysupplier.com](http://www.laparoscopysupplier.com)

Tel: +92-(0)-52-3 555674, 3254475 Fax: +92-(0)-52-3 556652, Cell: +92-(0)-300-8 717 212,



**Alispo** INTERNATIONAL

Manufacturers & Exporter of Surgical Instruments.

Filling Instrument # 3

**Alispo-80-710**

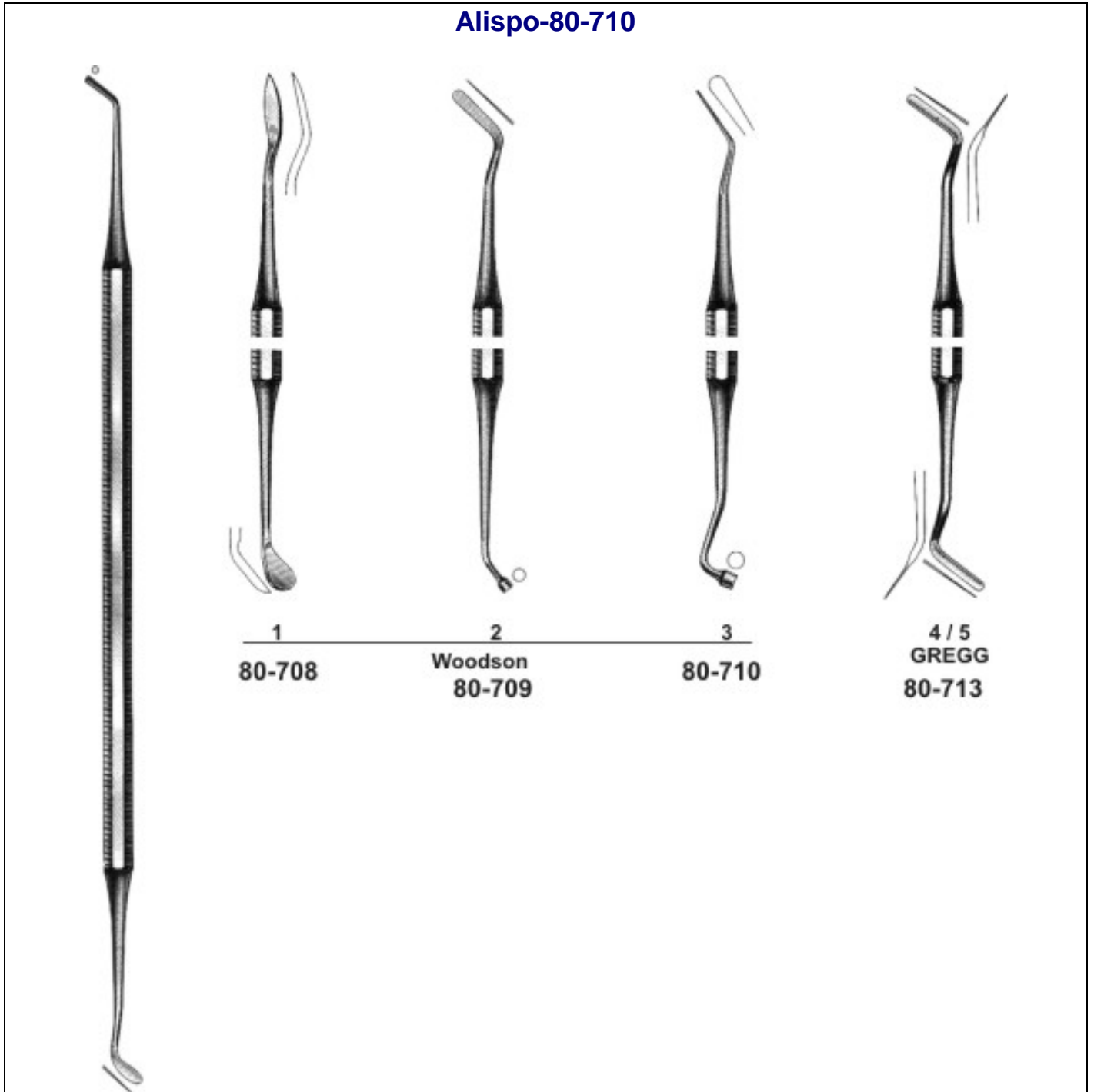

P.O. BOX-2872,

Roras Road' Muzaffar Pur' P.O. Small Industrial Estate' Sialkot "51310" Pakistan'

E-Mail: [info@alispo.com](mailto:info@alispo.com); [info@alispo.com.pk](mailto:info@alispo.com.pk) Web: [www.alispo.com](http://www.alispo.com); [www.alispo.com.pk](http://www.alispo.com.pk); [www.laparoscopysupplier.com](http://www.laparoscopysupplier.com)

Tel: +92-(0)-52-3 555674, 3254475 Fax: +92-(0)-52-3 556652, Cell: +92-(0)-300-8 717 212,



**Alispo** INTERNATIONAL

Manufacturers & Exporter of Surgical Instruments.

Filling Instrument Gregg # 4/5

**Alispo-80-713**

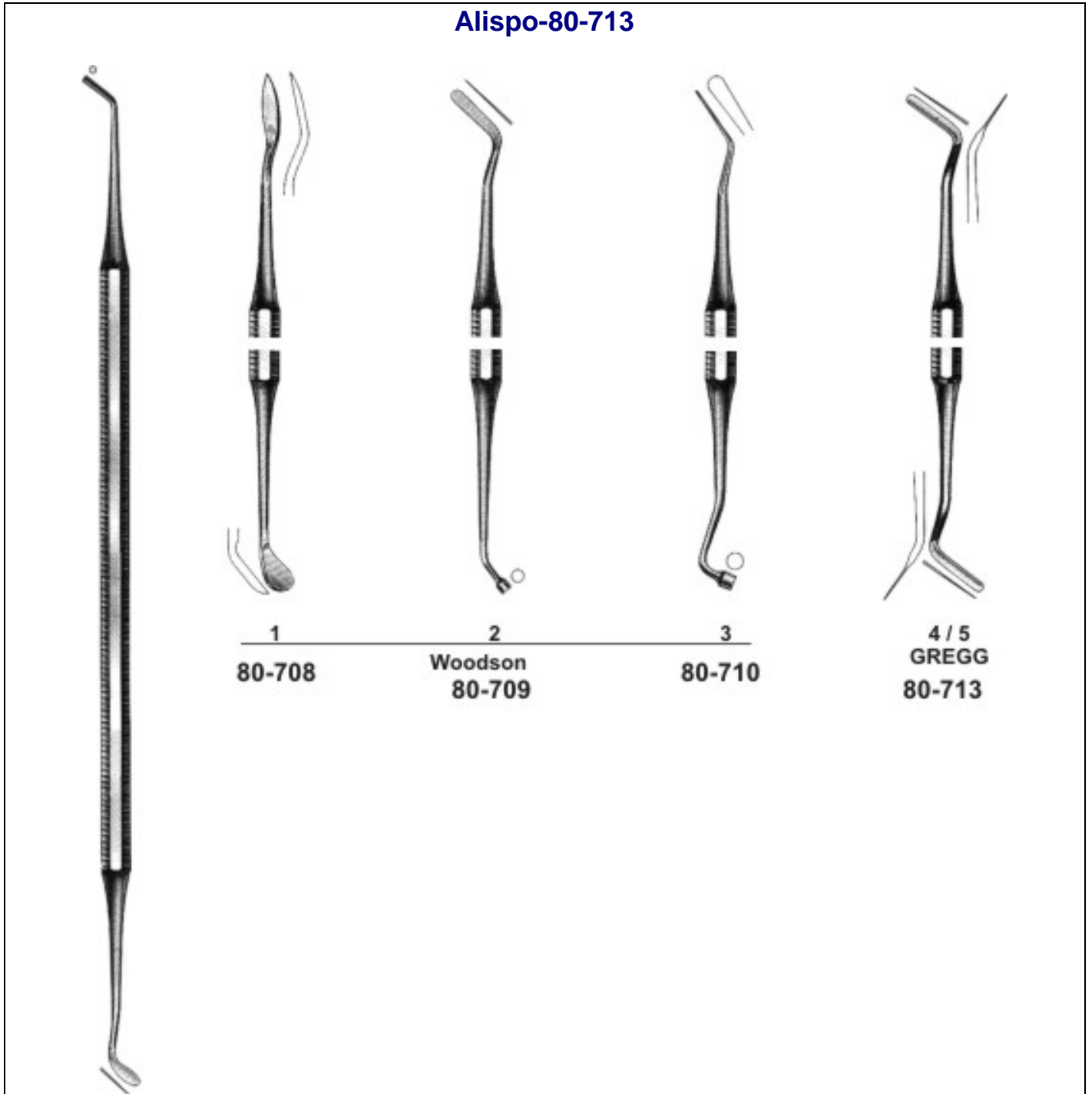

P.O. BOX-2872,

Roras Road' Muzaffar Pur' P.O. Small Industrial Estate' Sialkot "51310" Pakistan'

E-Mail: [info@alispo.com](mailto:info@alispo.com); [info@alispo.com.pk](mailto:info@alispo.com.pk) Web: [www.alispo.com](http://www.alispo.com); [www.alispo.com.pk](http://www.alispo.com.pk); [www.laparoscopysupplier.com](http://www.laparoscopysupplier.com)

Tel: +92-(0)-52-3 555674, 3254475 Fax: +92-(0)-52-3 556652, Cell: +92-(0)-300-8 717 212,



**Alispo** INTERNATIONAL

Manufacturers & Exporter of Surgical Instruments.

Amalgam Plugger. Behrman-1

**Alispo-80-717**



Behrman - 1

80-717



Black- 1 / 2  
80-718



Marquette - 0 / 1

80-719

**AMALGAM  
PLUGGERS**

P.O. BOX-2872,

Roras Road' Muzaffar Pur' P.O. Small Industrial Estate' Sialkot "51310" Pakistan'

E-Mail: [info@alispo.com](mailto:info@alispo.com); [info@alispo.com.pk](mailto:info@alispo.com.pk) Web: [www.alispo.com](http://www.alispo.com); [www.alispo.com.pk](http://www.alispo.com.pk); [www.laparoscopysupplier.com](http://www.laparoscopysupplier.com)

Tel: +92-(0)-52-3 555674, 3254475 Fax: +92-(0)-52-3 556652, Cell: +92-(0)-300-8 717 212,



**Alispo** INTERNATIONAL

Manufacturers & Exporter of Surgical Instruments.

Amalgam Plugger. Black-1/2

**Alispo-80-718**



Behrman - 1

80-717



Black- 1 / 2  
80-718

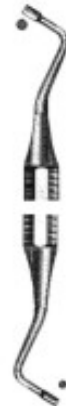

Marquette - 0 / 1

80-719

**AMALGAM  
PLUGGERS**

P.O. BOX-2872,

Roras Road' Muzaffar Pur' P.O. Small Industrial Estate' Sialkot "51310" Pakistan'

E-Mail: [info@alispo.com](mailto:info@alispo.com); [info@alispo.com.pk](mailto:info@alispo.com.pk) Web: [www.alispo.com](http://www.alispo.com); [www.alispo.com.pk](http://www.alispo.com.pk); [www.laparoscopysupplier.com](http://www.laparoscopysupplier.com)

Tel: +92-(0)-52-3 555674, 3254475 Fax: +92-(0)-52-3 556652, Cell: +92-(0)-300-8 717 212,



**Alispo** INTERNATIONAL

Manufacturers & Exporter of Surgical Instruments.

Amalgam Plugger. Marquette- 0/1

**Alispo-80-719**



Behrman - 1

80-717



Black- 1/2  
80-718



Marquette - 0 / 1

80-719

**AMALGAM  
PLUGGERS**

P.O. BOX-2872,

Roras Road' Muzaffar Pur' P.O. Small Industrial Estate' Sialkot "51310" Pakistan'

E-Mail: [info@alispo.com](mailto:info@alispo.com); [info@alispo.com.pk](mailto:info@alispo.com.pk) Web: [www.alispo.com](http://www.alispo.com); [www.alispo.com.pk](http://www.alispo.com.pk); [www.laparoscopysupplier.com](http://www.laparoscopysupplier.com)

Tel: +92-(0)-52-3 555674, 3254475 Fax: +92-(0)-52-3 556652, Cell: +92-(0)-300-8 717 212,



# Alispo INTERNATIONAL

Manufacturers & Exporter of Surgical Instruments.

## Burnishers # 1

### Alispo-80-723

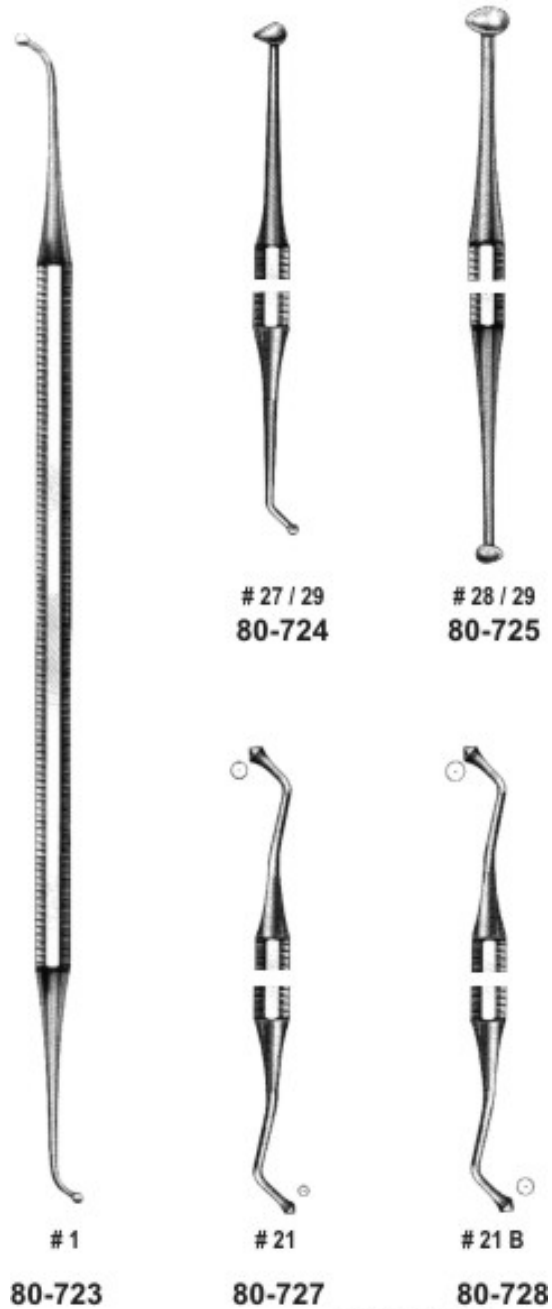

BURNISHERS



**Alispo** INTERNATIONAL

Manufacturers & Exporter of Surgical Instruments.

Burnishers # 27/29

**Alispo-80-724**

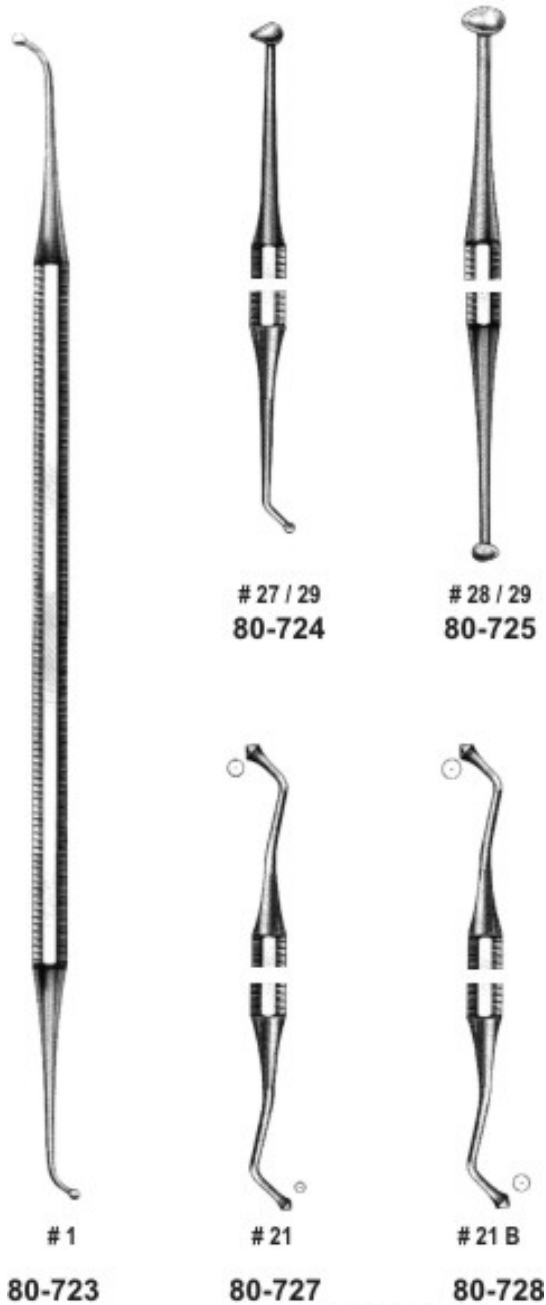

**BURNISHERS**



**Alispo** INTERNATIONAL

Manufacturers & Exporter of Surgical Instruments.

Burnishers # 28/29

**Alispo-80-725**

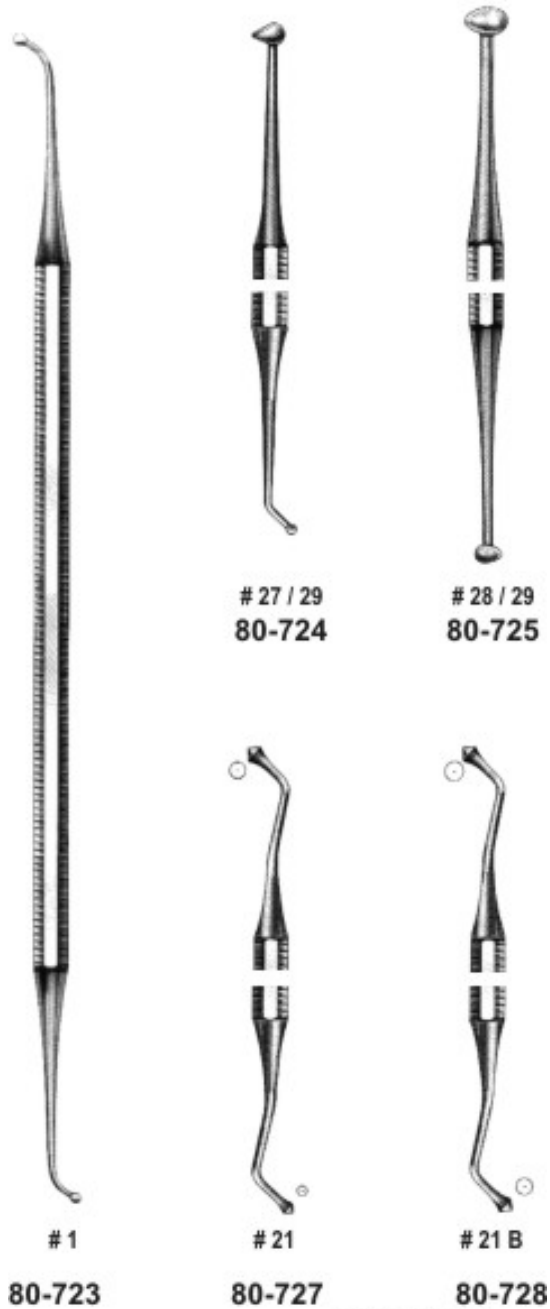

**BURNISHERS**



**Alispo** INTERNATIONAL

Manufacturers & Exporter of Surgical Instruments.

**Burnishers # 21**

**Alispo-80-727**

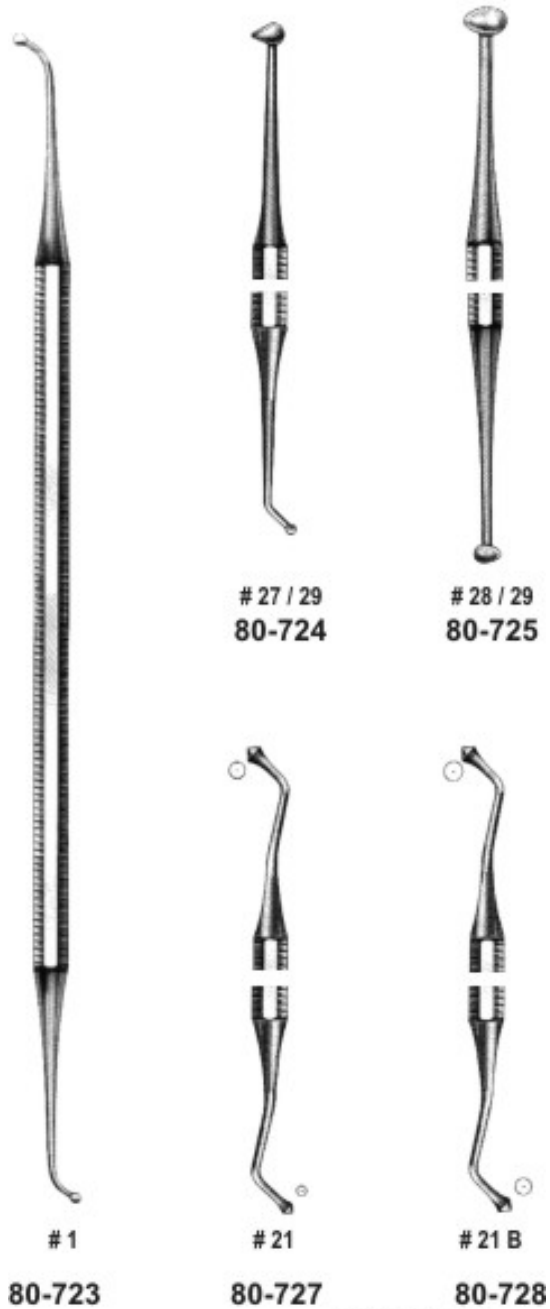

**BURNISHERS**



**Alispo** INTERNATIONAL

Manufacturers & Exporter of Surgical Instruments.

**Burnishers # 21 B**

**Alispo-80-728**

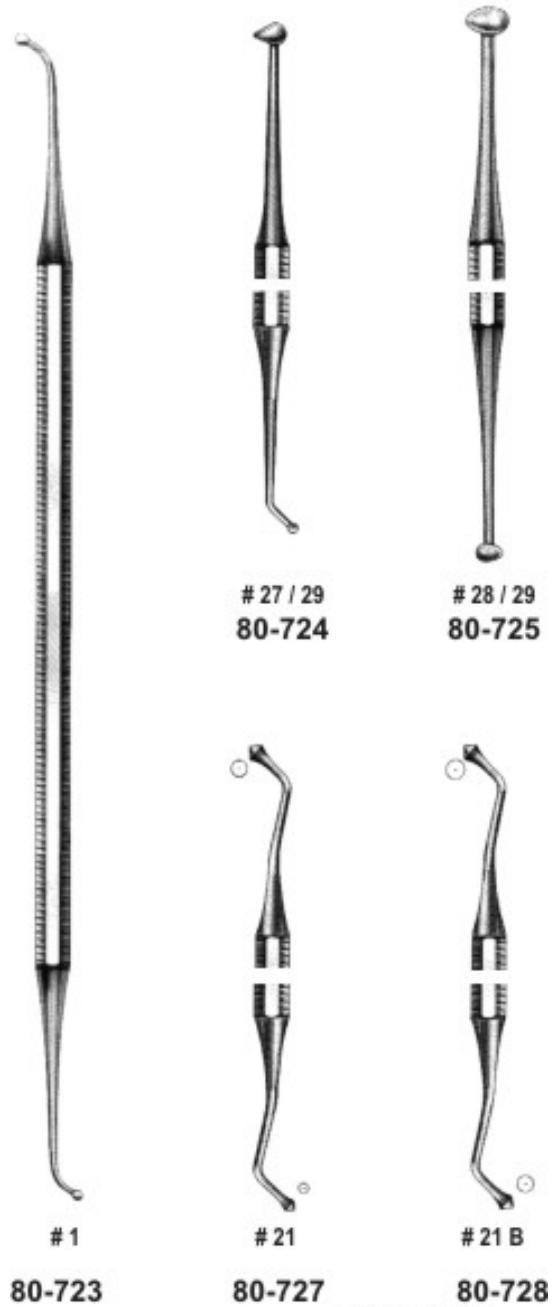

**BURNISHERS**



**Alispo** INTERNATIONAL

Manufacturers & Exporter of Surgical Instruments.

**Burnishers # 34**

**Alispo-80-730**



# 34

**80-730**

P.O. BOX-2872,

Roras Road' Muzaffar Pur' P.O. Small Industrial Estate' Sialkot "51310" Pakistan'

E-Mail: [info@alispo.com](mailto:info@alispo.com); [info@alispo.com.pk](mailto:info@alispo.com.pk) Web: [www.alispo.com](http://www.alispo.com); [www.alispo.com.pk](http://www.alispo.com.pk); [www.laparoscopysupplier.com](http://www.laparoscopysupplier.com)

Tel: +92-(0)-52-3 555674, 3254475 Fax: +92-(0)-52-3 556652, Cell: +92-(0)-300-8 717 212,



**Alispo** INTERNATIONAL

Manufacturers & Exporter of Surgical Instruments.

Scaler Jaquette # 1/1

**Alispo-80-401**

JAQUETTE

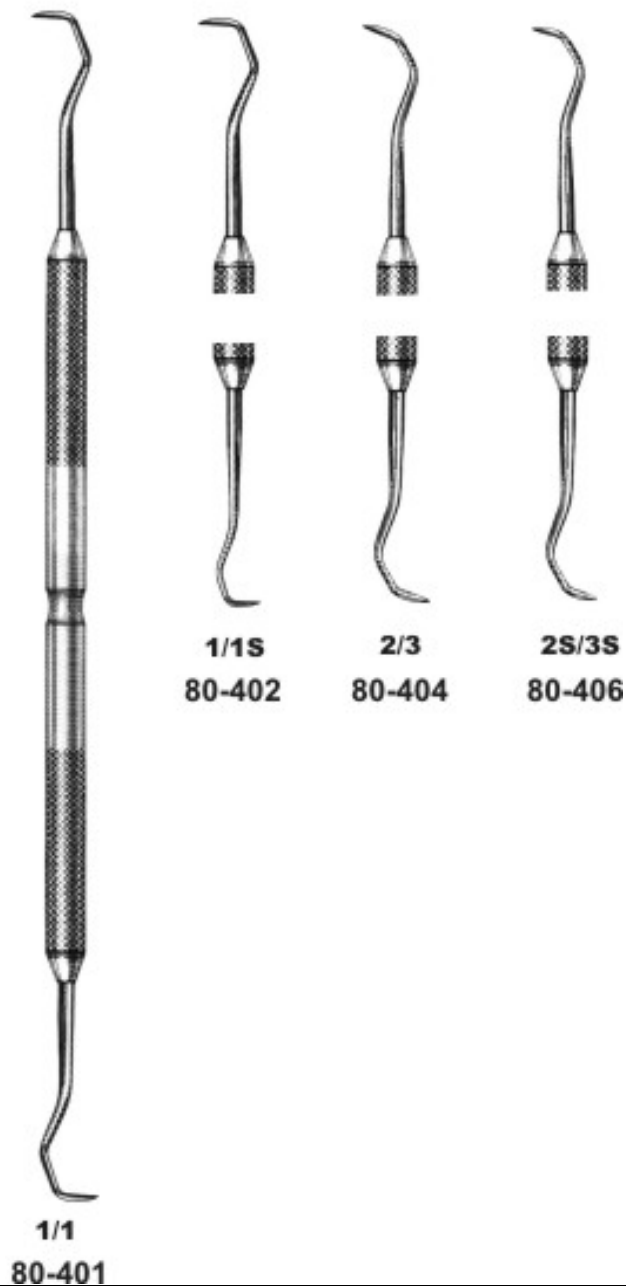

P.O. BOX-2872,

Roras Road' Muzaffar Pur' P.O. Small Industrial Estate' Sialkot "51310" Pakistan'

E-Mail: [info@alispo.com](mailto:info@alispo.com); [info@alispo.com.pk](mailto:info@alispo.com.pk) Web: [www.alispo.com](http://www.alispo.com); [www.alispo.com.pk](http://www.alispo.com.pk); [www.laparoscopysupplier.com](http://www.laparoscopysupplier.com)

Tel: +92-(0)-52-3 555674, 3254475 Fax: +92-(0)-52-3 556652, Cell: +92-(0)-300-8 717 212,



**Alispo** INTERNATIONAL

Manufacturers & Exporter of Surgical Instruments.

Scaler Jaquette # 1/1S

**Alispo-80-402**

JAQUETTE

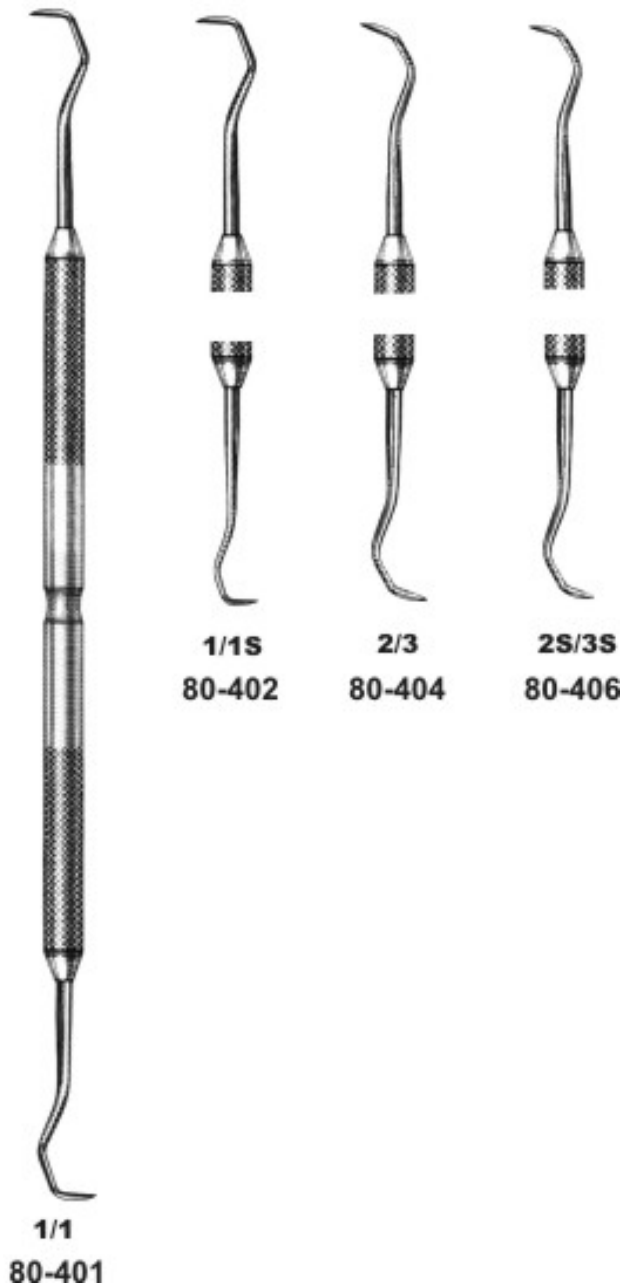

P.O. BOX-2872,

Roras Road' Muzaffar Pur' P.O. Small Industrial Estate' Sialkot "51310" Pakistan'

E-Mail: [info@alispo.com](mailto:info@alispo.com); [info@alispo.com.pk](mailto:info@alispo.com.pk) Web: [www.alispo.com](http://www.alispo.com); [www.alispo.com.pk](http://www.alispo.com.pk); [www.laparoscopysupplier.com](http://www.laparoscopysupplier.com)

Tel: +92-(0)-52-3 555674, 3254475 Fax: +92-(0)-52-3 556652, Cell: +92-(0)-300-8 717 212,



**Alispo** INTERNATIONAL

Manufacturers & Exporter of Surgical Instruments.

Scaler Jaquette # 2/3

**Alispo-80-404**

JAQUETTE

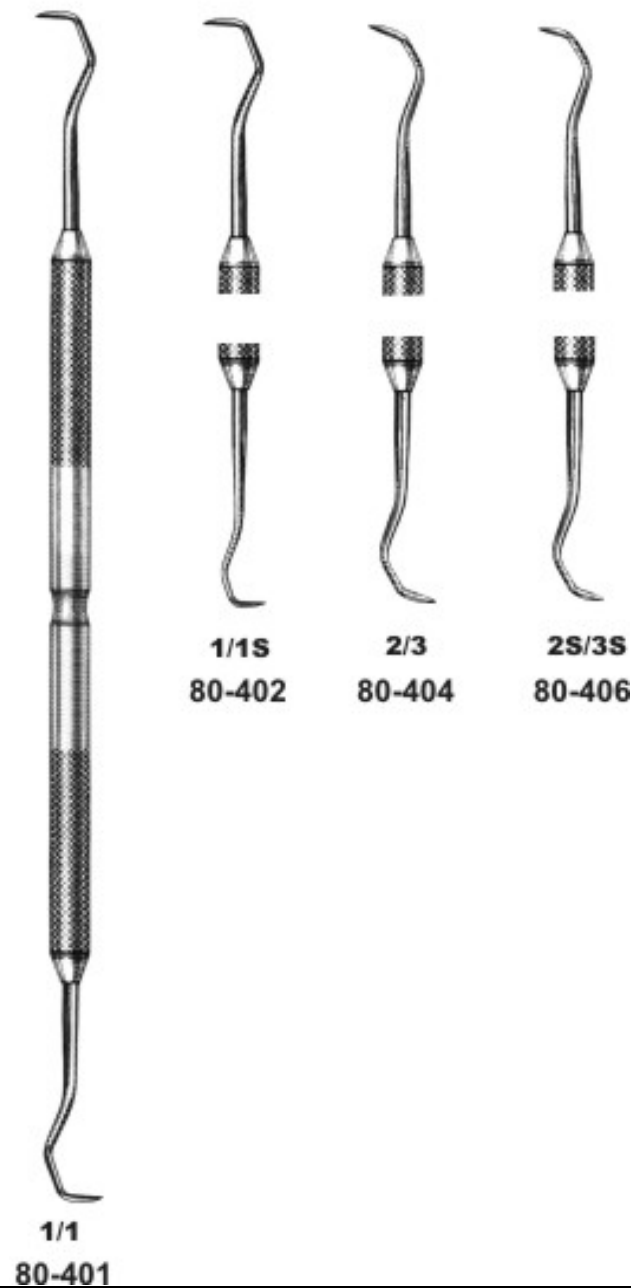

P.O. BOX-2872,

Roras Road' Muzaffar Pur' P.O. Small Industrial Estate' Sialkot "51310" Pakistan'

E-Mail: [info@alispo.com](mailto:info@alispo.com); [info@alispo.com.pk](mailto:info@alispo.com.pk) Web: [www.alispo.com](http://www.alispo.com); [www.alispo.com.pk](http://www.alispo.com.pk); [www.laparoscopysupplier.com](http://www.laparoscopysupplier.com)

Tel: +92-(0)-52-3 555674, 3254475 Fax: +92-(0)-52-3 556652, Cell: +92-(0)-300-8 717 212,



**Alispo** INTERNATIONAL

Manufacturers & Exporter of Surgical Instruments.

Scaler Jaquette # 2S/3S

**Alispo-80-406**

JAQUETTE

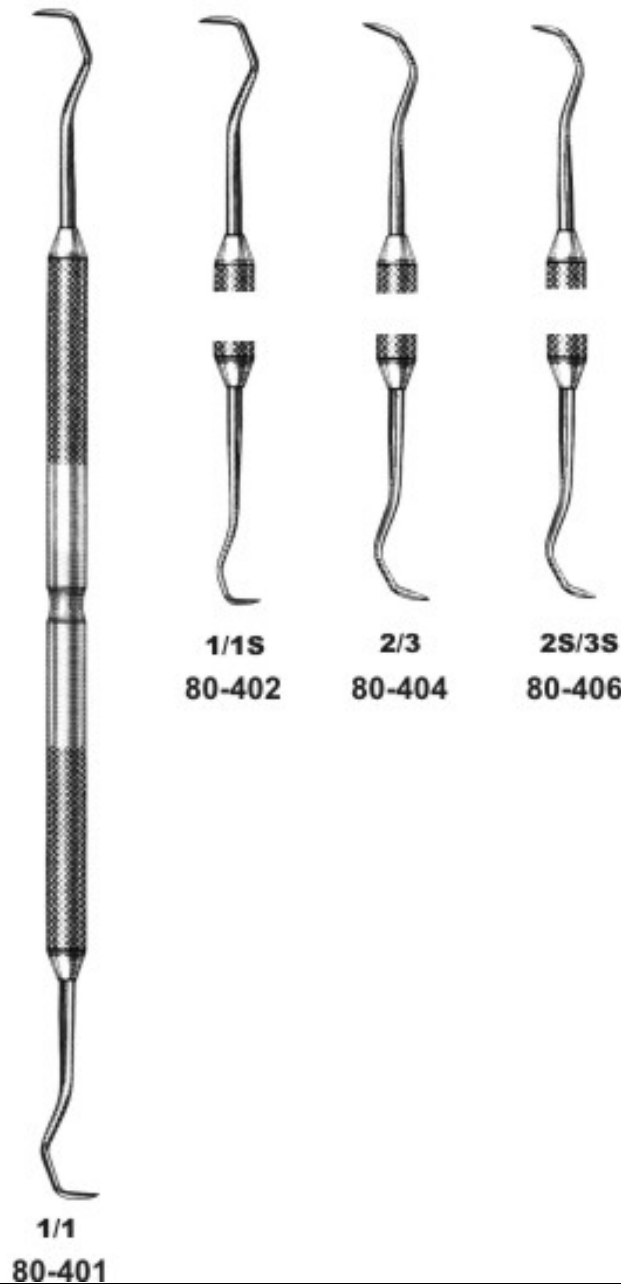

P.O. BOX-2872,

Roras Road' Muzaffar Pur' P.O. Small Industrial Estate' Sialkot "51310" Pakistan'

E-Mail: [info@alispo.com](mailto:info@alispo.com); [info@alispo.com.pk](mailto:info@alispo.com.pk) Web: [www.alispo.com](http://www.alispo.com); [www.alispo.com.pk](http://www.alispo.com.pk); [www.laparoscopysupplier.com](http://www.laparoscopysupplier.com)

Tel: +92-(0)-52-3 555674, 3254475 Fax: +92-(0)-52-3 556652, Cell: +92-(0)-300-8 717 212,



**Alispo** INTERNATIONAL

Manufacturers & Exporter of Surgical Instruments.

Scaler Columbia # 2L/2R

**Alispo-80-408**

**COLUMBIA**



**2L/2R**  
**80-408**

**4L/4R**  
**80-410**

**13/14**  
**80-412**

P.O. BOX-2872,

Roras Road' Muzaffar Pur' P.O. Small Industrial Estate' Sialkot "51310" Pakistan'

E-Mail: [info@alispo.com](mailto:info@alispo.com); [info@alispo.com.pk](mailto:info@alispo.com.pk) Web: [www.alispo.com](http://www.alispo.com); [www.alispo.com.pk](http://www.alispo.com.pk); [www.laparoscopysupplier.com](http://www.laparoscopysupplier.com)

Tel: +92-(0)-52-3 555674, 3254475 Fax: +92-(0)-52-3 556652, Cell: +92-(0)-300-8 717 212,



**Alispo** INTERNATIONAL

Manufacturers & Exporter of Surgical Instruments.

Scaler Columbia # 4L/4R

**Alispo-80-410**

**COLUMBIA**



**2L/2R**  
**80-408**

**4L/4R**  
**80-410**

**13/14**  
**80-412**

P.O. BOX-2872,

Roras Road' Muzaffar Pur' P.O. Small Industrial Estate' Sialkot "51310" Pakistan'

E-Mail: [info@alispo.com](mailto:info@alispo.com); [info@alispo.com.pk](mailto:info@alispo.com.pk) Web: [www.alispo.com](http://www.alispo.com); [www.alispo.com.pk](http://www.alispo.com.pk); [www.laparoscopysupplier.com](http://www.laparoscopysupplier.com)

Tel: +92-(0)-52-3 555674, 3254475 Fax: +92-(0)-52-3 556652, Cell: +92-(0)-300-8 717 212,



**Alispo** INTERNATIONAL

Manufacturers & Exporter of Surgical Instruments.

Scaler Columbia # 13/14

**Alispo-80-412**

**COLUMBIA**



**2L/2R**  
**80-408**



**4L/4R**  
**80-410**



**13/14**  
**80-412**

P.O. BOX-2872,

Roras Road' Muzaffar Pur' P.O. Small Industrial Estate' Sialkot "51310" Pakistan'

E-Mail: [info@alispo.com](mailto:info@alispo.com); [info@alispo.com.pk](mailto:info@alispo.com.pk) Web: [www.alispo.com](http://www.alispo.com); [www.alispo.com.pk](http://www.alispo.com.pk); [www.laparoscopysupplier.com](http://www.laparoscopysupplier.com)

Tel: +92-(0)-52-3 555674, 3254475 Fax: +92-(0)-52-3 556652, Cell: +92-(0)-300-8 717 212,



**Alispo** INTERNATIONAL

Manufacturers & Exporter of Surgical Instruments.

Scaler McCALLS. # 13/14

**Alispo-80-414**



**McCALLS**



**13/14**  
**80-414**

**13S/14S**  
**80-416**

**17/18**  
**80-418**

**17S/18S**  
**80-420**

P.O. BOX-2872,

Roras Road' Muzaffar Pur' P.O. Small Industrial Estate' Sialkot "51310" Pakistan'

E-Mail: [info@alispo.com](mailto:info@alispo.com); [info@alispo.com.pk](mailto:info@alispo.com.pk) Web: [www.alispo.com](http://www.alispo.com); [www.alispo.com.pk](http://www.alispo.com.pk); [www.laparoscopysupplier.com](http://www.laparoscopysupplier.com)

Tel: +92-(0)-52-3 555674, 3254475 Fax: +92-(0)-52-3 556652, Cell: +92-(0)-300-8 717 212,



**Alispo** INTERNATIONAL

Manufacturers & Exporter of Surgical Instruments.

Scaler McCALLS. # 13S/14S

**Alispo-80-416**



**McCALLS**



**13/14**  
**80-414**

**13S/14S**  
**80-416**

**17/18**  
**80-418**

**17S/18S**  
**80-420**

P.O. BOX-2872,

Roras Road' Muzaffar Pur' P.O. Small Industrial Estate' Sialkot "51310" Pakistan'

E-Mail: [info@alispo.com](mailto:info@alispo.com); [info@alispo.com.pk](mailto:info@alispo.com.pk) Web: [www.alispo.com](http://www.alispo.com); [www.alispo.com.pk](http://www.alispo.com.pk); [www.laparoscopiesupplier.com](http://www.laparoscopiesupplier.com)

Tel: +92-(0)-52-3 555674, 3254475 Fax: +92-(0)-52-3 556652, Cell: +92-(0)-300-8 717 212,



**Alispo** INTERNATIONAL

Manufacturers & Exporter of Surgical Instruments.

Scaler McCALLS. #17/18

**Alispo-80-418**



**McCALLS**



**13/14**  
**80-414**

**13S/14S**  
**80-416**

**17/18**  
**80-418**

**17S/18S**  
**80-420**

P.O. BOX-2872,

Roras Road' Muzaffar Pur' P.O. Small Industrial Estate' Sialkot "51310" Pakistan'

E-Mail: [info@alispo.com](mailto:info@alispo.com); [info@alispo.com.pk](mailto:info@alispo.com.pk) Web: [www.alispo.com](http://www.alispo.com); [www.alispo.com.pk](http://www.alispo.com.pk); [www.laparoscopiesupplier.com](http://www.laparoscopiesupplier.com)

Tel: +92-(0)-52-3 555674, 3254475 Fax: +92-(0)-52-3 556652, Cell: +92-(0)-300-8 717 212,



**Alispo** INTERNATIONAL

Manufacturers & Exporter of Surgical Instruments.

Scaler McCALLS. #17S/18S

**Alispo-80-420**

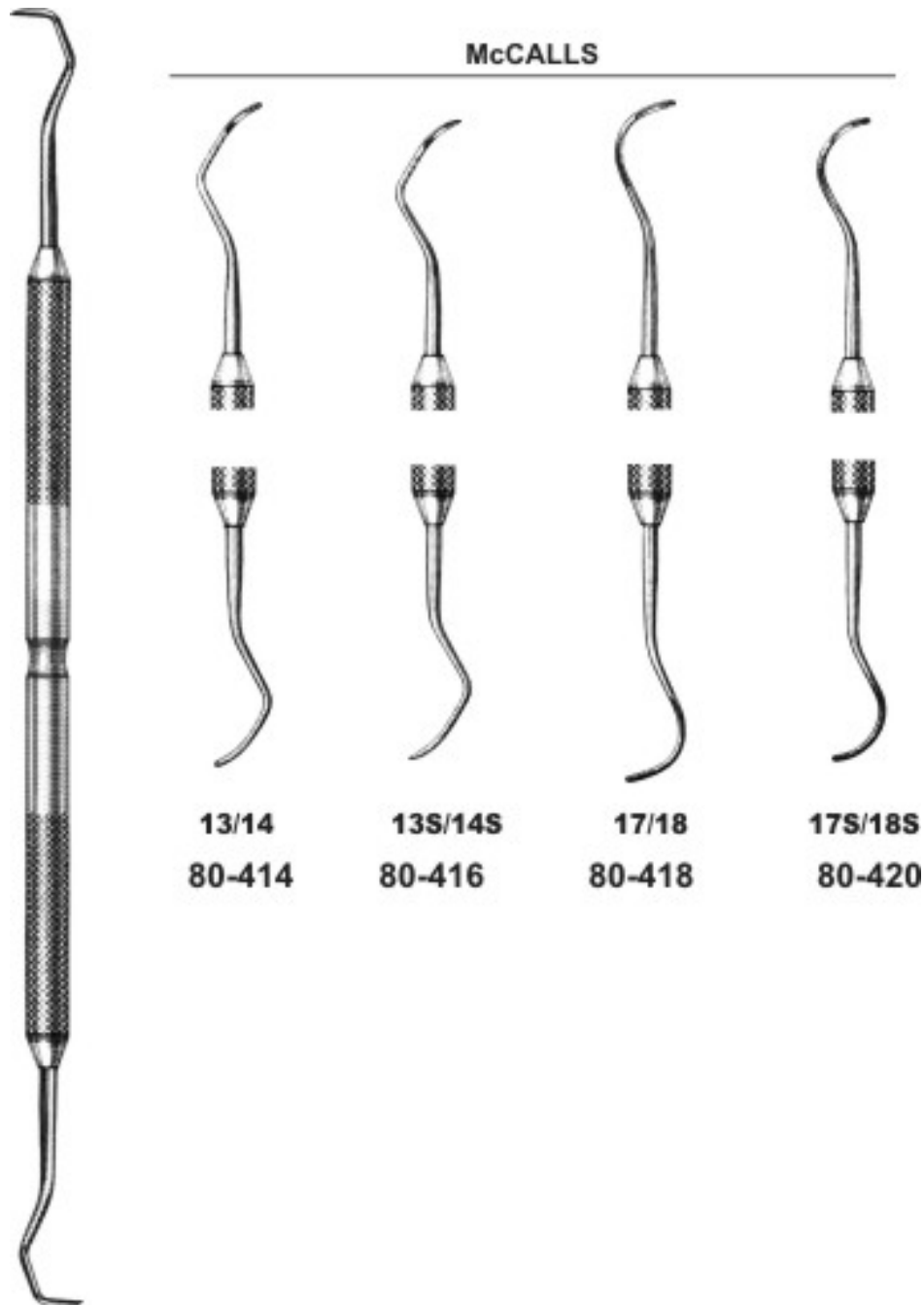

P.O. BOX-2872,

Roras Road' Muzaffar Pur' P.O. Small Industrial Estate' Sialkot "51310" Pakistan'

E-Mail: [info@alispo.com](mailto:info@alispo.com); [info@alispo.com.pk](mailto:info@alispo.com.pk) Web: [www.alispo.com](http://www.alispo.com); [www.alispo.com.pk](http://www.alispo.com.pk); [www.laparoscopiesupplier.com](http://www.laparoscopiesupplier.com)

Tel: +92-(0)-52-3 555674, 3254475 Fax: +92-(0)-52-3 556652, Cell: +92-(0)-300-8 717 212,



**Alispo** INTERNATIONAL

Manufacturers & Exporter of Surgical Instruments.

Scaler Gracey # 1/2

**Alispo-80-422**

GRACEY

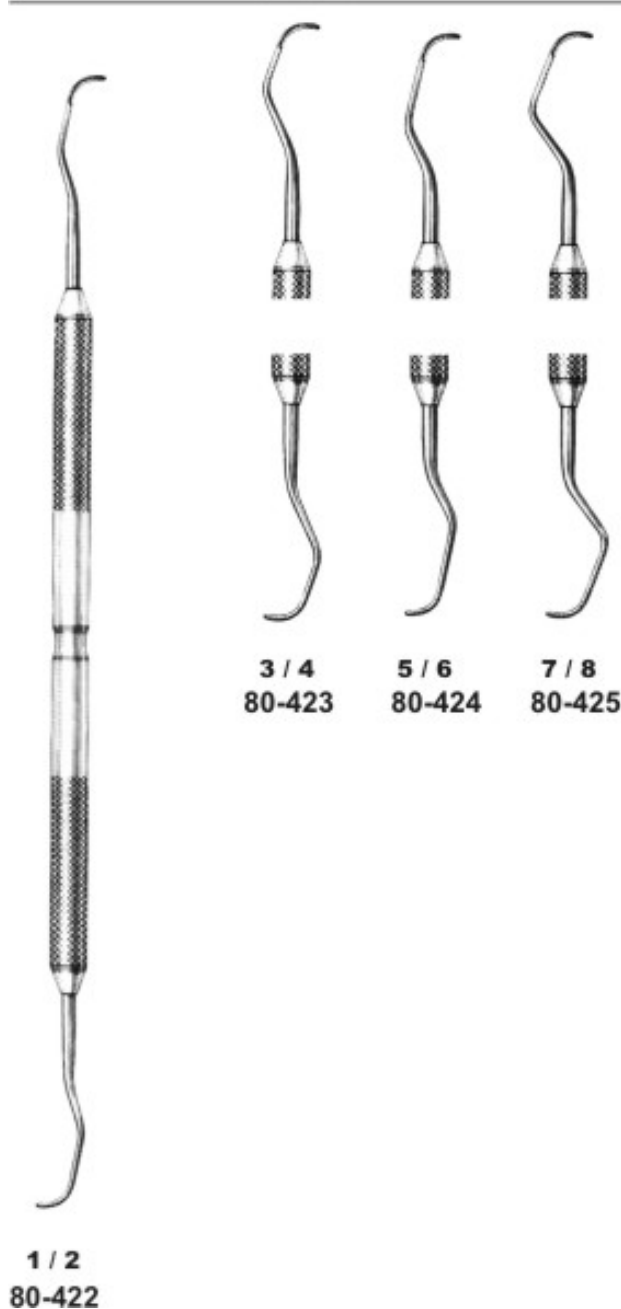



**Alispo** INTERNATIONAL

Manufacturers & Exporter of Surgical Instruments.

Scaler Gracey # 3/4

**Alispo-80-423**

GRACEY

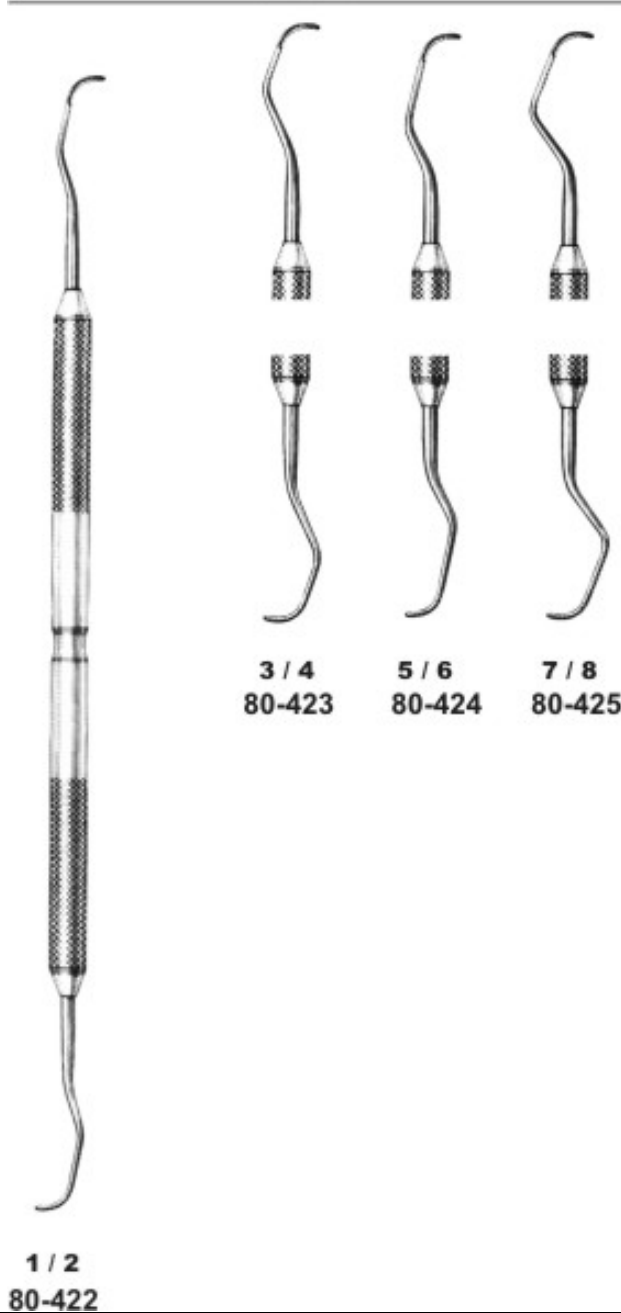

P.O. BOX-2872,

Roras Road' Muzaffar Pur' P.O. Small Industrial Estate' Sialkot "51310" Pakistan'

E-Mail: [info@alispo.com](mailto:info@alispo.com); [info@alispo.com.pk](mailto:info@alispo.com.pk) Web: [www.alispo.com](http://www.alispo.com); [www.alispo.com.pk](http://www.alispo.com.pk); [www.laparoscopysupplier.com](http://www.laparoscopysupplier.com)

Tel: +92-(0)-52-3 555674, 3254475 Fax: +92-(0)-52-3 556652, Cell: +92-(0)-300-8 717 212,



**Alispo** INTERNATIONAL

Manufacturers & Exporter of Surgical Instruments.

Scaler Gracey # 5/6

**Alispo-80-424**

GRACEY

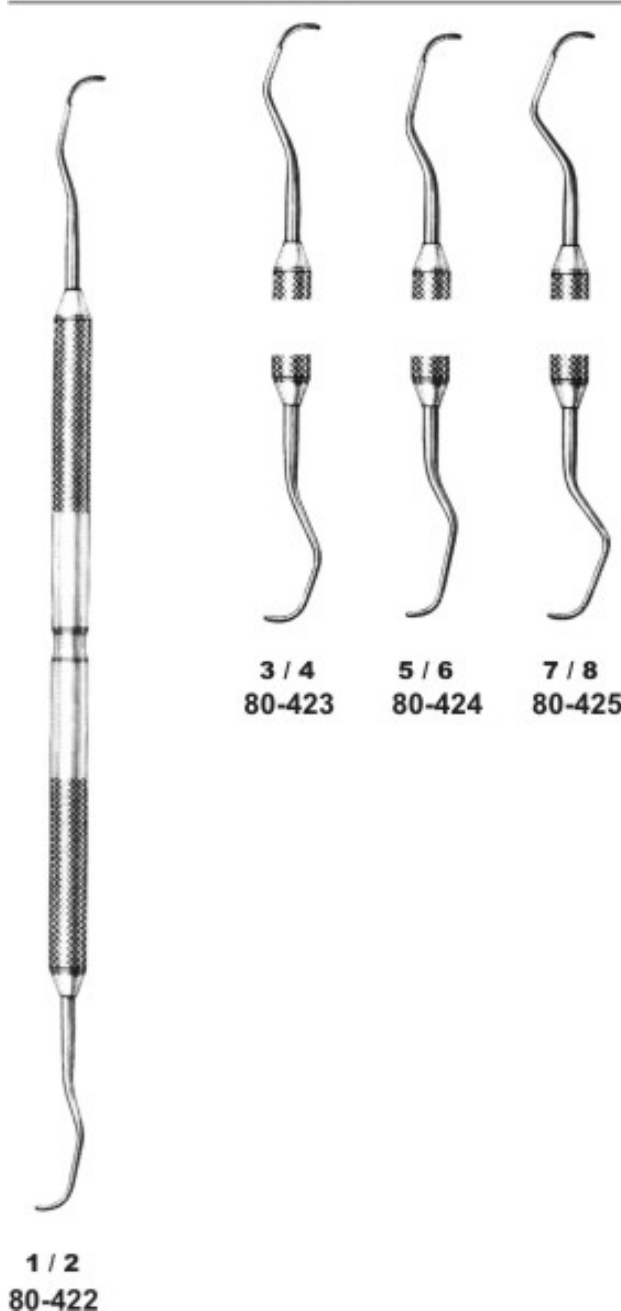

P.O. BOX-2872,

Roras Road' Muzaffar Pur' P.O. Small Industrial Estate' Sialkot "51310" Pakistan'

E-Mail: [info@alispo.com](mailto:info@alispo.com); [info@alispo.com.pk](mailto:info@alispo.com.pk) Web: [www.alispo.com](http://www.alispo.com); [www.alispo.com.pk](http://www.alispo.com.pk); [www.laparoscopysupplier.com](http://www.laparoscopysupplier.com)

Tel: +92-(0)-52-3 555674, 3254475 Fax: +92-(0)-52-3 556652, Cell: +92-(0)-300-8 717 212,



**Alispo** INTERNATIONAL

Manufacturers & Exporter of Surgical Instruments.

Scaler Gracey # 7/8

**Alispo-80-425**

GRACEY

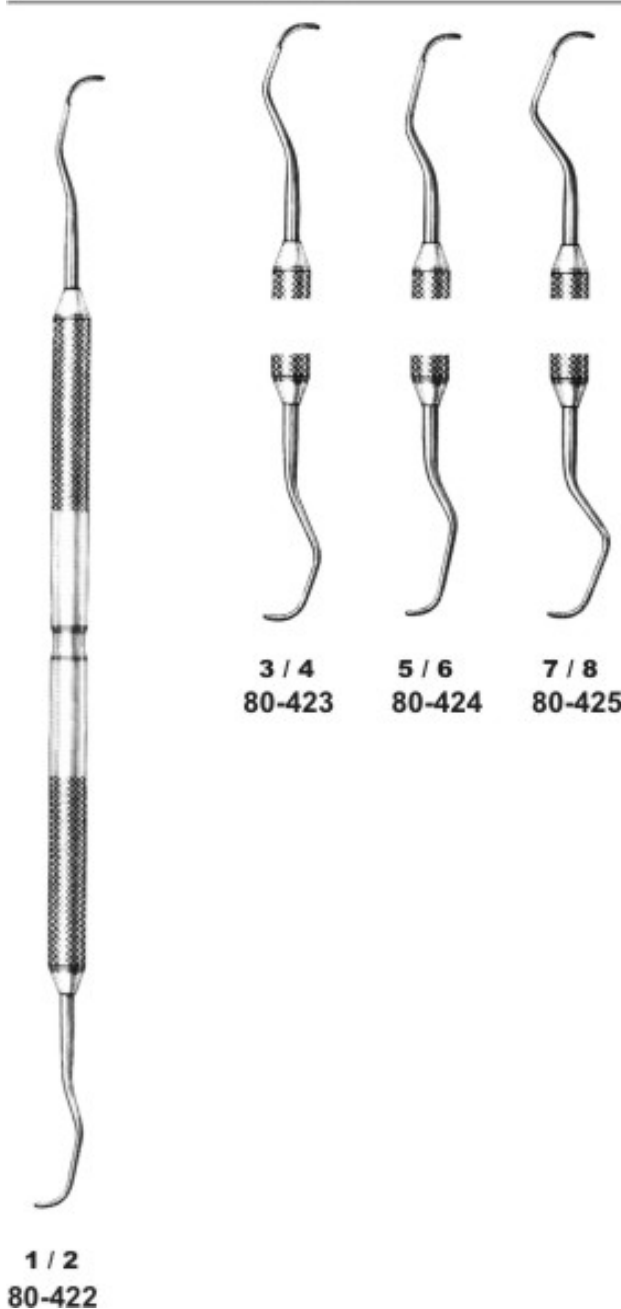



**Alispo** INTERNATIONAL

Manufacturers & Exporter of Surgical Instruments.

Scaler Gracey # 9/10

**Alispo-80-426**

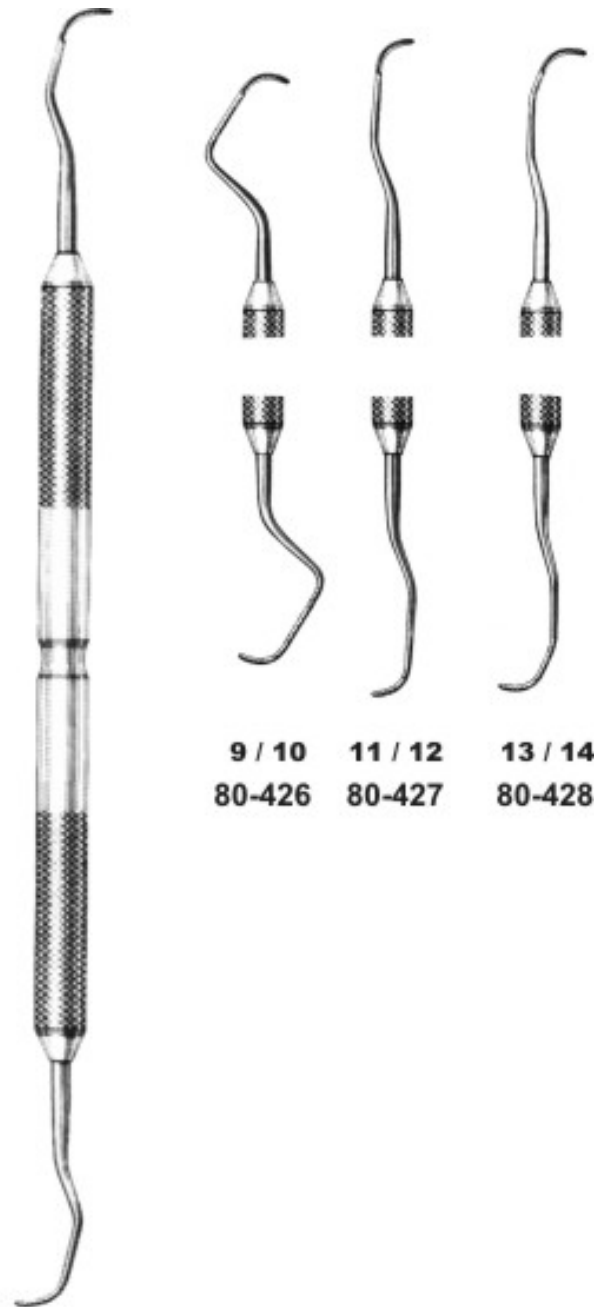

<b>9 / 10</b>	<b>11 / 12</b>	<b>13 / 14</b>
<b>80-426</b>	<b>80-427</b>	<b>80-428</b>



**Alispo** INTERNATIONAL

Manufacturers & Exporter of Surgical Instruments.

Scaler Gracey # 11/12

**Alispo-80-427**

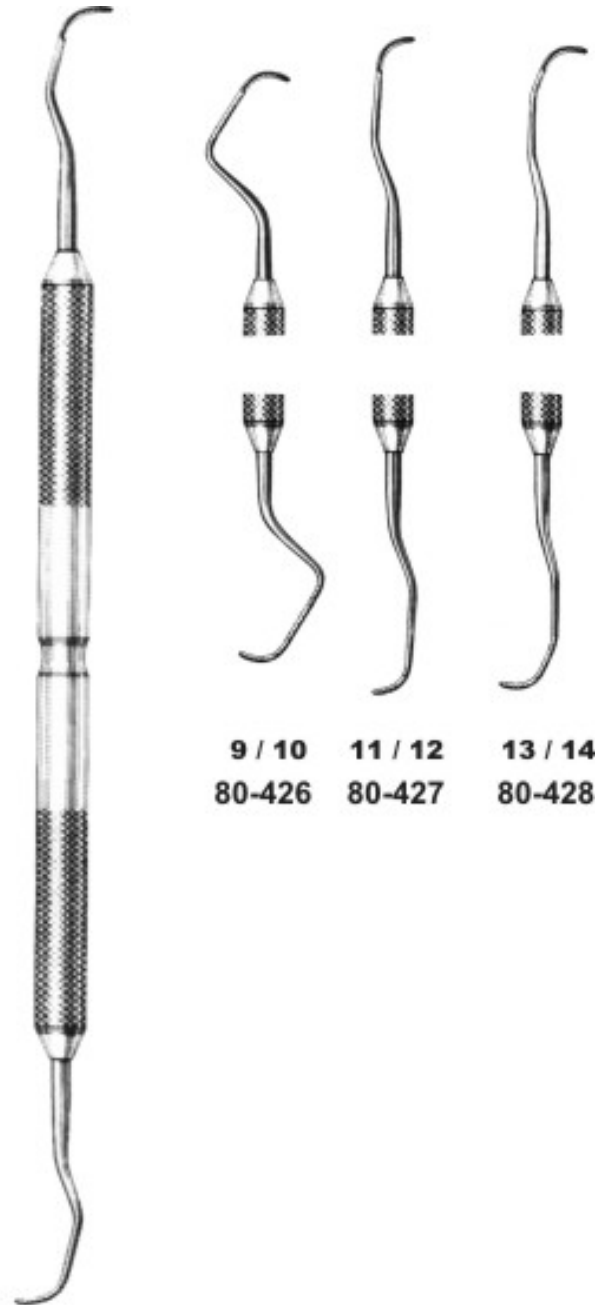

**9 / 10    11 / 12    13 / 14**  
**80-426    80-427    80-428**



**Alispo** INTERNATIONAL

Manufacturers & Exporter of Surgical Instruments.

Scaler Gracey # 13/14

**Alispo-80-428**

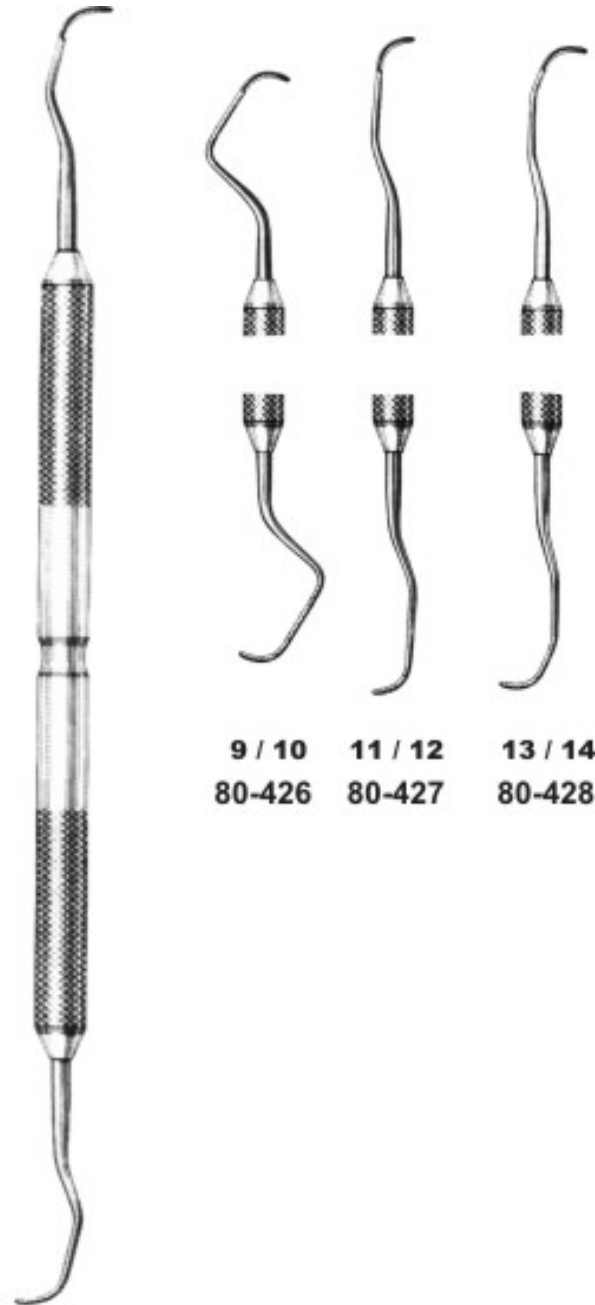

**9 / 10    11 / 12    13 / 14**  
**80-426    80-427    80-428**



**Alispo** INTERNATIONAL

Manufacturers & Exporter of Surgical Instruments.

Scaler Jacquette # 1

**Alispo-80-430**

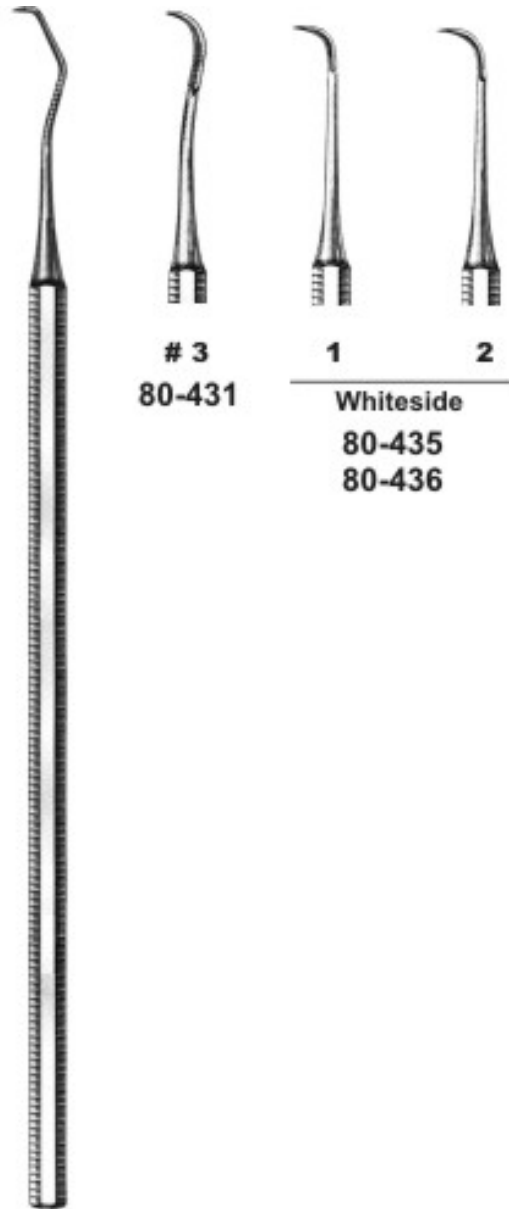

# 3  
80-431

1      2  
-----  
Whiteside  
80-435  
80-436

JACQUETTE  
1  
80-430



**Alispo** INTERNATIONAL

Manufacturers & Exporter of Surgical Instruments.

Scaler Jacquette # 3

**Alispo-80-431**

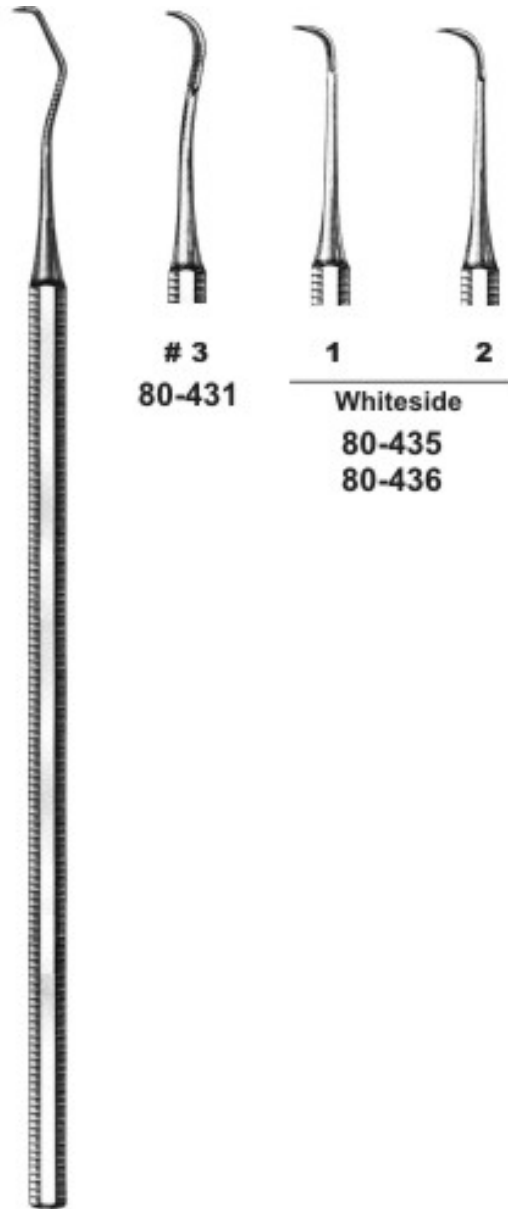

JACQUETTE  
1  
80-430

# 3  
80-431

---

Whiteside  
80-435  
80-436

P.O. BOX-2872,

Roras Road' Muzaffar Pur' P.O. Small Industrial Estate' Sialkot "51310" Pakistan'

E-Mail: [info@alispo.com](mailto:info@alispo.com); [info@alispo.com.pk](mailto:info@alispo.com.pk) Web: [www.alispo.com](http://www.alispo.com); [www.alispo.com.pk](http://www.alispo.com.pk); [www.laparoscopysupplier.com](http://www.laparoscopysupplier.com)

Tel: +92-(0)-52-3 555674, 3254475 Fax: +92-(0)-52-3 556652, Cell: +92-(0)-300-8 717 212,



**Alispo** INTERNATIONAL

Manufacturers & Exporter of Surgical Instruments.

Scaler Whiteside # 1

**Alispo-80-435**

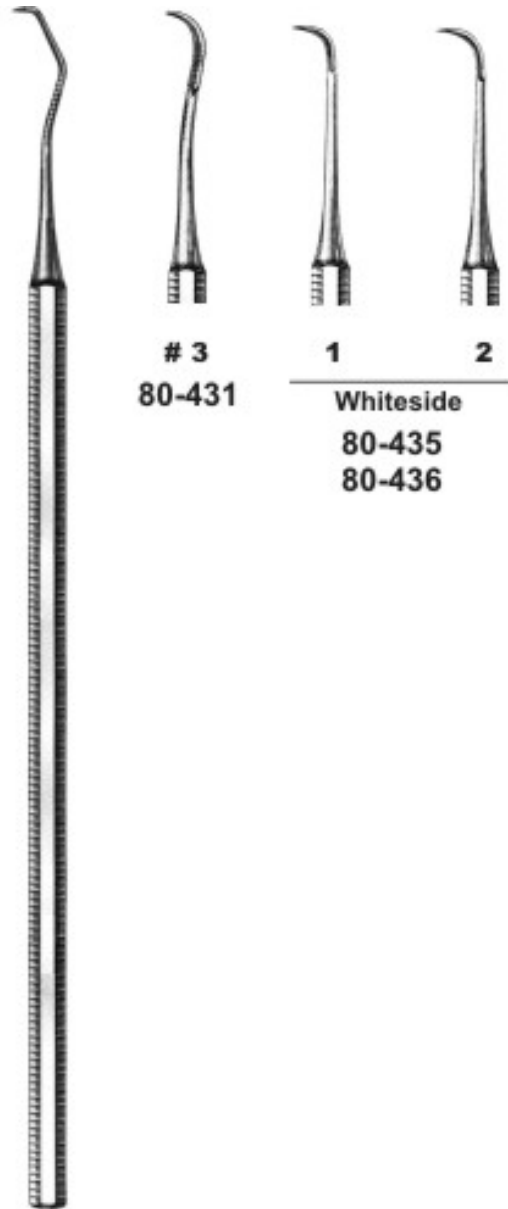

JACQUETTE  
1  
80-430

P.O. BOX-2872,

Roras Road' Muzaffar Pur' P.O. Small Industrial Estate' Sialkot "51310" Pakistan'

E-Mail: [info@alispo.com](mailto:info@alispo.com); [info@alispo.com.pk](mailto:info@alispo.com.pk) Web: [www.alispo.com](http://www.alispo.com); [www.alispo.com.pk](http://www.alispo.com.pk); [www.laparoscopysupplier.com](http://www.laparoscopysupplier.com)

Tel: +92-(0)-52-3 555674, 3254475 Fax: +92-(0)-52-3 556652, Cell: +92-(0)-300-8 717 212,



**Alispo** INTERNATIONAL

Manufacturers & Exporter of Surgical Instruments.

Scaler Whiteside # 2

**Alispo-80-436**

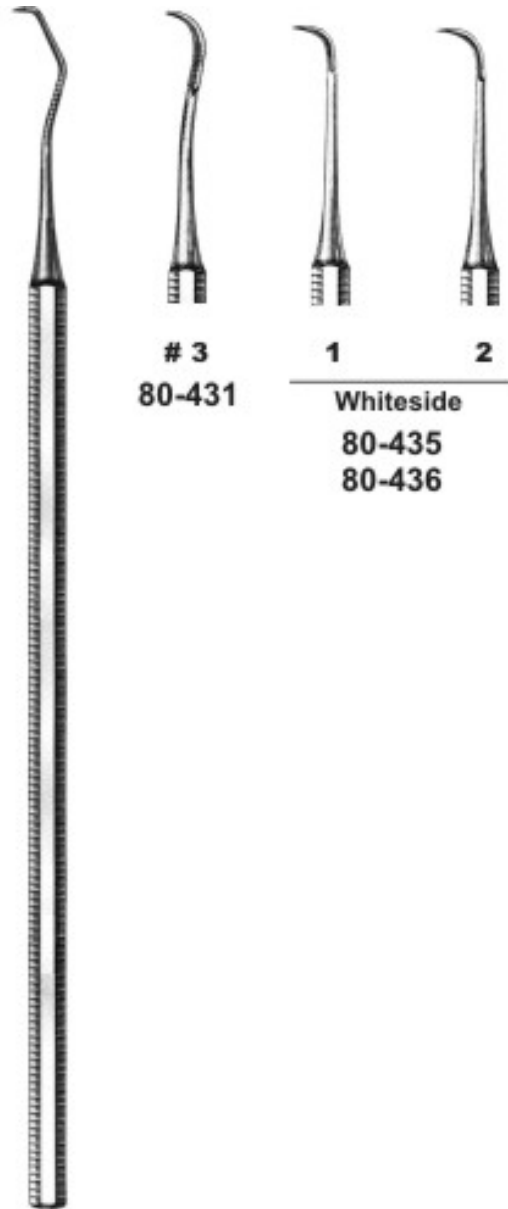

JACQUETTE  
1  
80-430

P.O. BOX-2872,

Roras Road' Muzaffar Pur' P.O. Small Industrial Estate' Sialkot "51310" Pakistan'

E-Mail: [info@alispo.com](mailto:info@alispo.com); [info@alispo.com.pk](mailto:info@alispo.com.pk) Web: [www.alispo.com](http://www.alispo.com); [www.alispo.com.pk](http://www.alispo.com.pk); [www.laparoscopysupplier.com](http://www.laparoscopysupplier.com)

Tel: +92-(0)-52-3 555674, 3254475 Fax: +92-(0)-52-3 556652, Cell: +92-(0)-300-8 717 212,



# Alispo INTERNATIONAL

Manufacturers & Exporter of Surgical Instruments.

## Scaler Jacquette # 2/3

### Alispo-80-440



Jacquette  
2 / 3  
80-440



Jacquette  
2S / 3S  
80-441



# 12  
80-443



# 204S  
80-444



Younger  
7 / 8  
80-446



Crane-Kaplan  
6  
80-448



**Alispo** INTERNATIONAL

Manufacturers & Exporter of Surgical Instruments.

**Scaler Jacquette #2S/3S**

**Alispo-80-441**



**Jacquette  
2 / 3  
80-440**



**Jacquette  
2S / 3S  
80-441**



**# 12  
80-443**



**# 204S  
80-444**



**Younger  
7 / 8  
80-446**



**Crane-Kaplan  
6  
80-448**

P.O. BOX-2872,

Roras Road' Muzaffar Pur' P.O. Small Industrial Estate' Sialkot "51310" Pakistan'

E-Mail: [info@alispo.com](mailto:info@alispo.com); [info@alispo.com.pk](mailto:info@alispo.com.pk) Web: [www.alispo.com](http://www.alispo.com); [www.alispo.com.pk](http://www.alispo.com.pk); [www.laparoscopysupplier.com](http://www.laparoscopysupplier.com)

Tel: +92-(0)-52-3 555674, 3254475 Fax: +92-(0)-52-3 556652, Cell: +92-(0)-300-8 717 212,



# Alispo INTERNATIONAL

Manufacturers & Exporter of Surgical Instruments.

## Scaler # 12

### Alispo-80-443



Jacquette  
2 / 3  
80-440



Jacquette  
2S / 3S  
80-441



# 12  
80-443



# 204S  
80-444

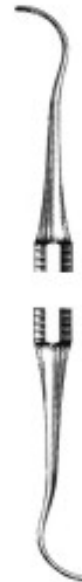

Younger  
7 / 8  
80-446



Crane-Kaplan  
6  
80-448

P.O. BOX-2872,

Roras Road' Muzaffar Pur' P.O. Small Industrial Estate' Sialkot "51310" Pakistan'

E-Mail: [info@alispo.com](mailto:info@alispo.com); [info@alispo.com.pk](mailto:info@alispo.com.pk) Web: [www.alispo.com](http://www.alispo.com); [www.alispo.com.pk](http://www.alispo.com.pk); [www.laparoscopysupplier.com](http://www.laparoscopysupplier.com)

Tel: +92-(0)-52-3 555674, 3254475 Fax: +92-(0)-52-3 556652, Cell: +92-(0)-300-8 717 212,



# Alispo INTERNATIONAL

Manufacturers & Exporter of Surgical Instruments.

## Scaler # 204 S

### Alispo-80-444



Jacquette  
2 / 3  
80-440



Jacquette  
2S / 3S  
80-441



# 12  
80-443



# 204S  
80-444

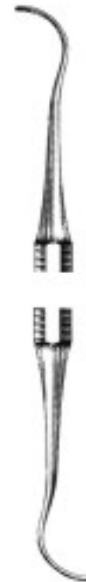

Younger  
7 / 8  
80-446



Crane-Kaplan  
6  
80-448

P.O. BOX-2872,

Roras Road' Muzaffar Pur' P.O. Small Industrial Estate' Sialkot "51310" Pakistan'

E-Mail: [info@alispo.com](mailto:info@alispo.com); [info@alispo.com.pk](mailto:info@alispo.com.pk) Web: [www.alispo.com](http://www.alispo.com); [www.alispo.com.pk](http://www.alispo.com.pk); [www.laparoscopysupplier.com](http://www.laparoscopysupplier.com)

Tel: +92-(0)-52-3 555674, 3254475 Fax: +92-(0)-52-3 556652, Cell: +92-(0)-300-8 717 212,



**Alispo** INTERNATIONAL

Manufacturers & Exporter of Surgical Instruments.

Scaler Younger # 7/8

**Alispo-80-446**



Jacquette  
2 / 3  
**80-440**



Jacquette  
2S / 3S  
**80-441**



# 12  
**80-443**



# 204S  
**80-444**



Younger  
7 / 8  
**80-446**



Crane-Kaplan  
6  
**80-448**

P.O. BOX-2872,

Roras Road' Muzaffar Pur' P.O. Small Industrial Estate' Sialkot "51310" Pakistan'

E-Mail: [info@alispo.com](mailto:info@alispo.com); [info@alispo.com.pk](mailto:info@alispo.com.pk) Web: [www.alispo.com](http://www.alispo.com); [www.alispo.com.pk](http://www.alispo.com.pk); [www.laparoscopysupplier.com](http://www.laparoscopysupplier.com)

Tel: +92-(0)-52-3 555674, 3254475 Fax: +92-(0)-52-3 556652, Cell: +92-(0)-300-8 717 212,



**Alispo** INTERNATIONAL

Manufacturers & Exporter of Surgical Instruments.

Scaler Crane Kaplan # 6

**Alispo-80-448**



Jacquette  
2 / 3  
**80-440**



Jacquette  
2S / 3S  
**80-441**



# 12  
**80-443**



# 204S  
**80-444**



Younger  
7 / 8  
**80-446**



Crane-Kaplan  
6  
**80-448**

P.O. BOX-2872,

Roras Road' Muzaffar Pur' P.O. Small Industrial Estate' Sialkot "51310" Pakistan'

E-Mail: [info@alispo.com](mailto:info@alispo.com); [info@alispo.com.pk](mailto:info@alispo.com.pk) Web: [www.alispo.com](http://www.alispo.com); [www.alispo.com.pk](http://www.alispo.com.pk); [www.laparoscopysupplier.com](http://www.laparoscopysupplier.com)

Tel: +92-(0)-52-3 555674, 3254475 Fax: +92-(0)-52-3 556652, Cell: +92-(0)-300-8 717 212,



**Alispo** INTERNATIONAL

Manufacturers & Exporter of Surgical Instruments.

Scaler # U15/30

**Alispo-80-452**

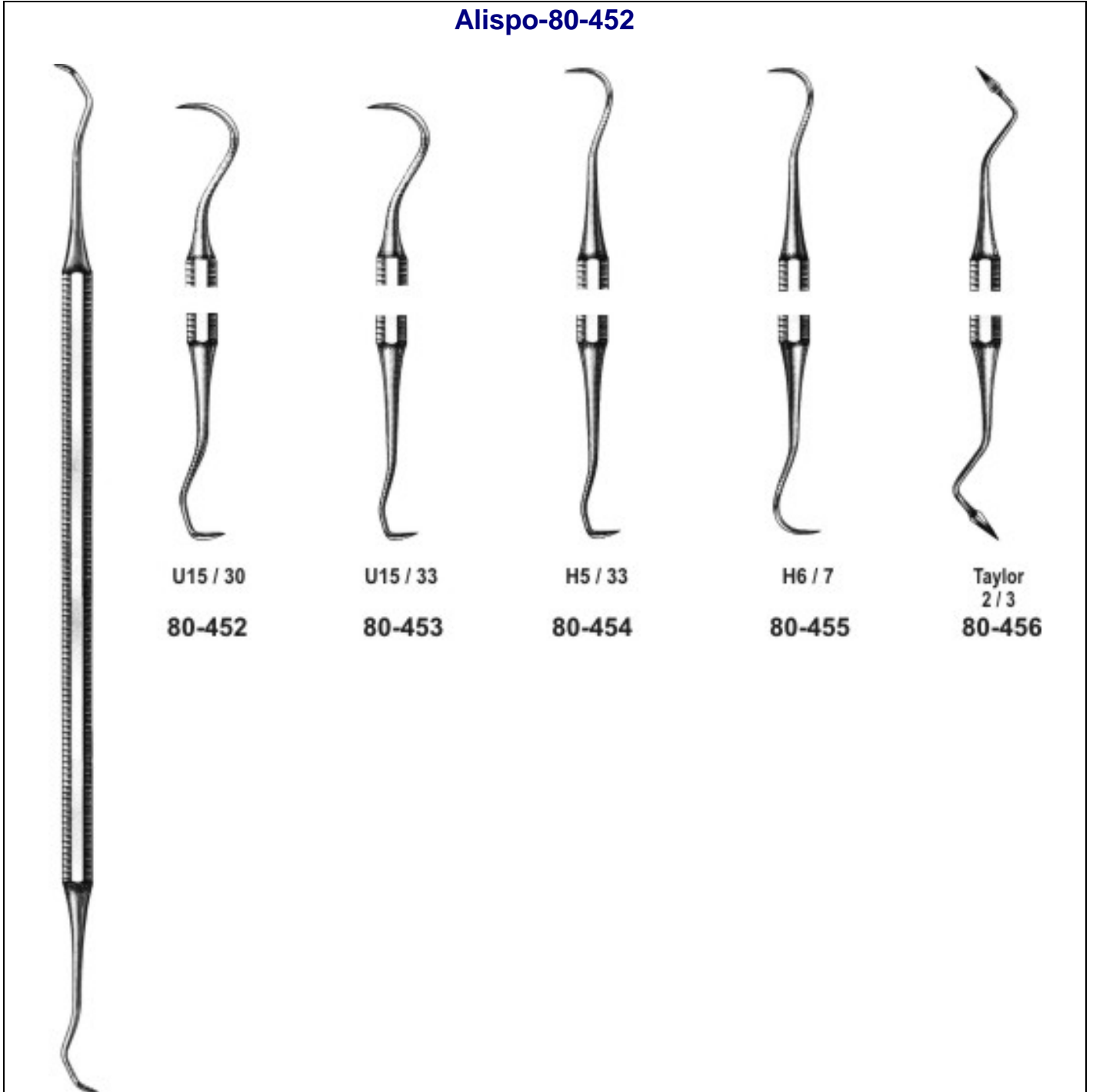

U15 / 30  
80-452

U15 / 33  
80-453

H5 / 33  
80-454

H6 / 7  
80-455

Taylor  
2 / 3  
80-456

P.O. BOX-2872,

Roras Road' Muzaffar Pur' P.O. Small Industrial Estate' Sialkot "51310" Pakistan'

E-Mail: [info@alispo.com](mailto:info@alispo.com); [info@alispo.com.pk](mailto:info@alispo.com.pk) Web: [www.alispo.com](http://www.alispo.com); [www.alispo.com.pk](http://www.alispo.com.pk); [www.laparoscopysupplier.com](http://www.laparoscopysupplier.com)

Tel: +92-(0)-52-3 555674, 3254475 Fax: +92-(0)-52-3 556652, Cell: +92-(0)-300-8 717 212,



**Alispo** INTERNATIONAL

Manufacturers & Exporter of Surgical Instruments.

Scaler # U15/33

**Alispo-80-453**

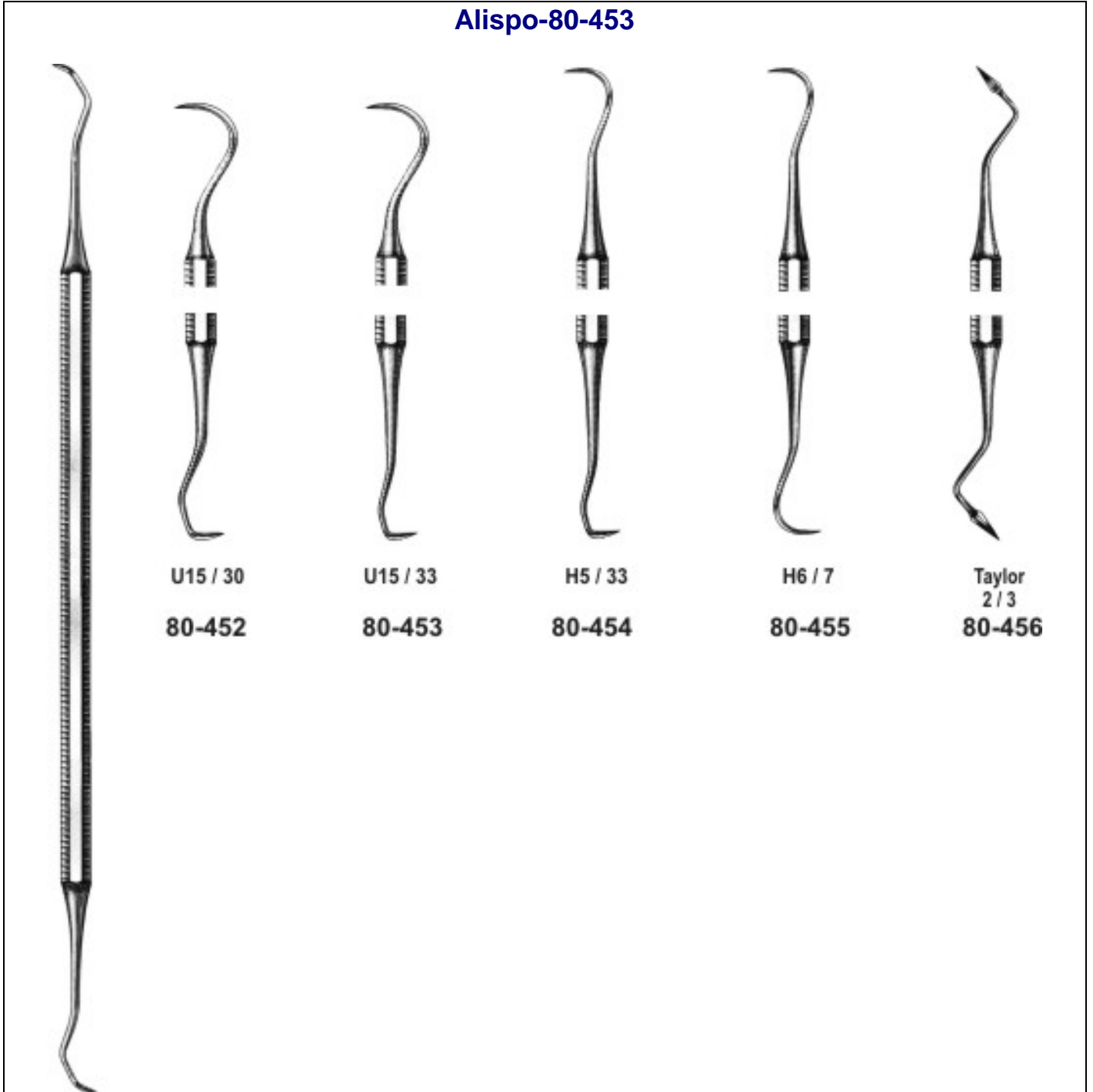

P.O. BOX-2872,

Roras Road' Muzaffar Pur' P.O. Small Industrial Estate' Sialkot "51310" Pakistan'

E-Mail: [info@alispo.com](mailto:info@alispo.com); [info@alispo.com.pk](mailto:info@alispo.com.pk) Web: [www.alispo.com](http://www.alispo.com); [www.alispo.com.pk](http://www.alispo.com.pk); [www.laparoscopysupplier.com](http://www.laparoscopysupplier.com)

Tel: +92-(0)-52-3 555674, 3254475 Fax: +92-(0)-52-3 556652, Cell: +92-(0)-300-8 717 212,



**Alispo** INTERNATIONAL

Manufacturers & Exporter of Surgical Instruments.

Scaler # H5/33

**Alispo-80-454**

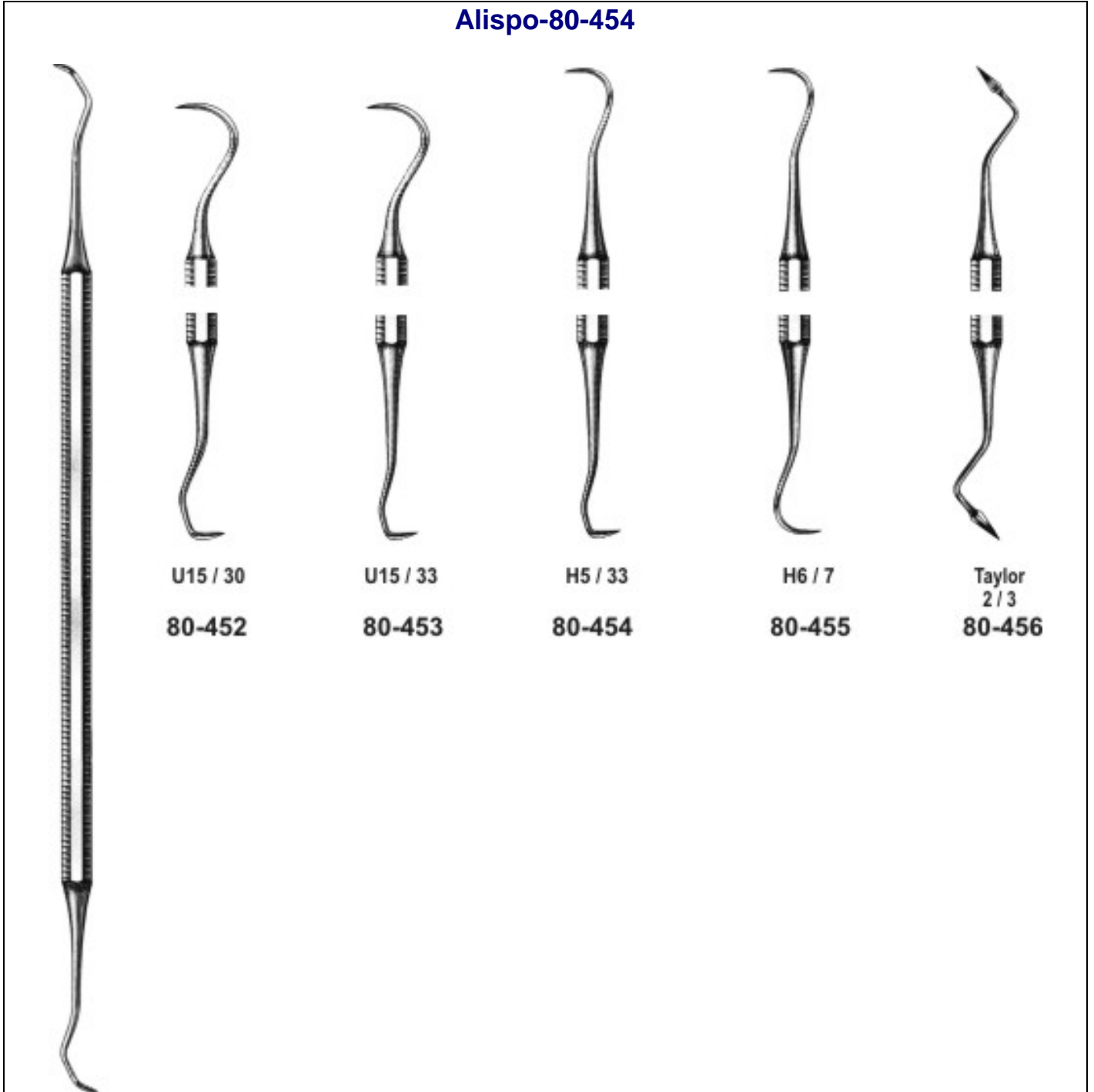

P.O. BOX-2872,

Roras Road' Muzaffar Pur' P.O. Small Industrial Estate' Sialkot "51310" Pakistan'

E-Mail: [info@alispo.com](mailto:info@alispo.com); [info@alispo.com.pk](mailto:info@alispo.com.pk) Web: [www.alispo.com](http://www.alispo.com); [www.alispo.com.pk](http://www.alispo.com.pk); [www.laparoscopysupplier.com](http://www.laparoscopysupplier.com)

Tel: +92-(0)-52-3 555674, 3254475 Fax: +92-(0)-52-3 556652, Cell: +92-(0)-300-8 717 212,



**Alispo** INTERNATIONAL

Manufacturers & Exporter of Surgical Instruments.

Scaler # H6/7

**Alispo-80-455**

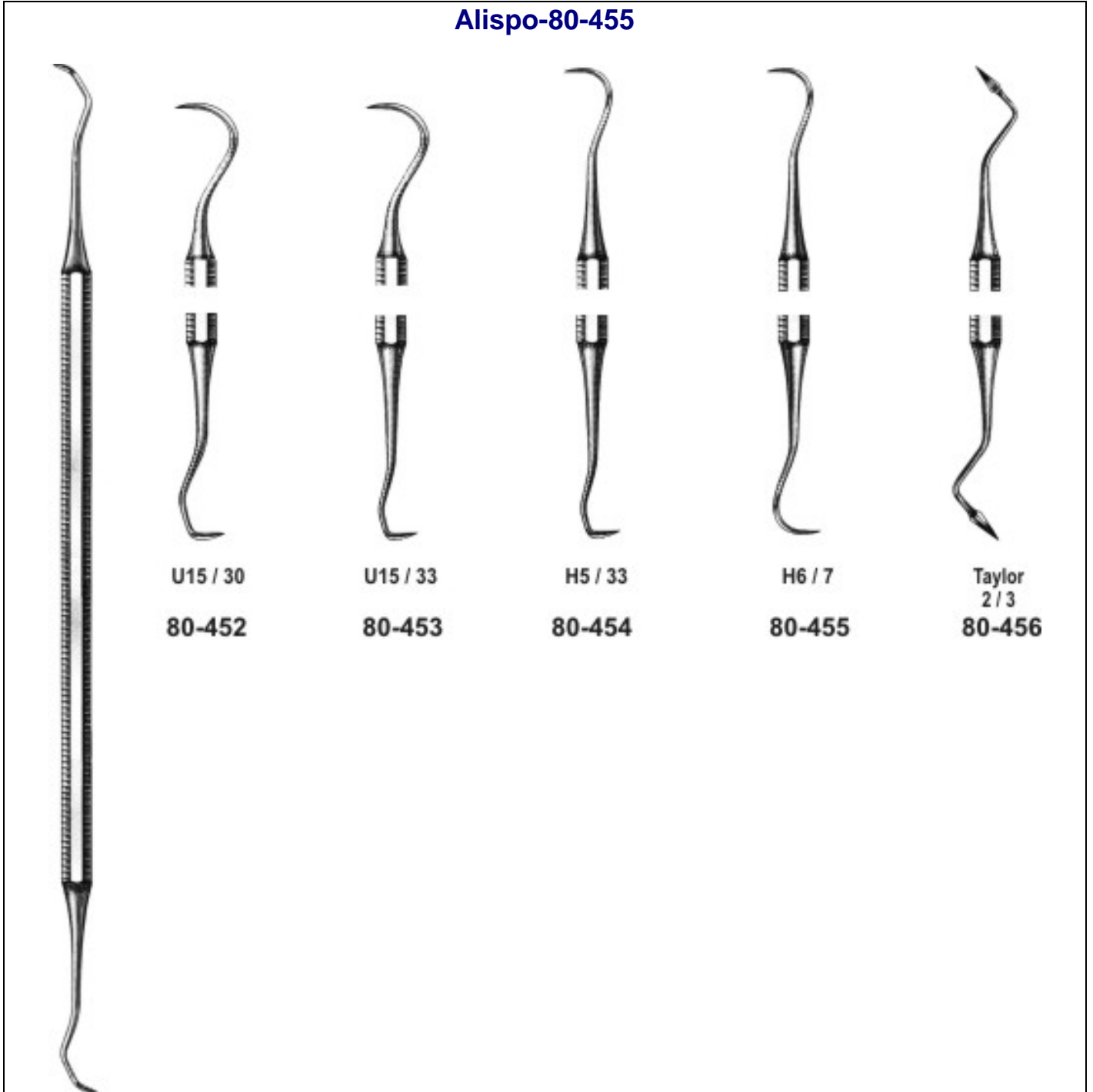

P.O. BOX-2872,

Roras Road' Muzaffar Pur' P.O. Small Industrial Estate' Sialkot "51310" Pakistan'

E-Mail: [info@alispo.com](mailto:info@alispo.com); [info@alispo.com.pk](mailto:info@alispo.com.pk) Web: [www.alispo.com](http://www.alispo.com); [www.alispo.com.pk](http://www.alispo.com.pk); [www.laparoscopiesupplier.com](http://www.laparoscopiesupplier.com)

Tel: +92-(0)-52-3 555674, 3254475 Fax: +92-(0)-52-3 556652, Cell: +92-(0)-300-8 717 212,



**Alispo** INTERNATIONAL

Manufacturers & Exporter of Surgical Instruments.

Scaler Taylor # 2/3

**Alispo-80-456**

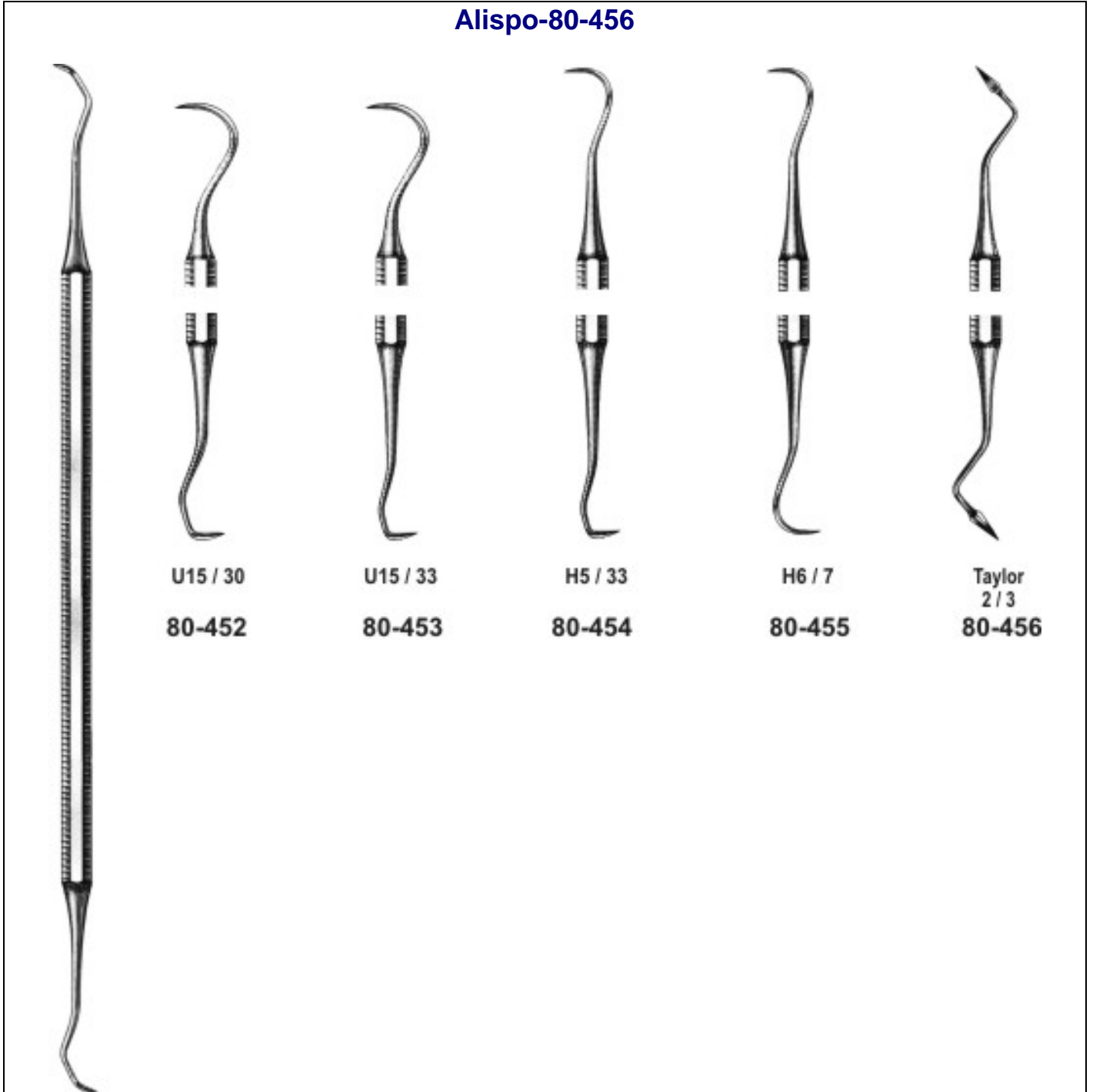

U15 / 30  
80-452

U15 / 33  
80-453

H5 / 33  
80-454

H6 / 7  
80-455

Taylor  
2 / 3  
80-456

P.O. BOX-2872,

Roras Road' Muzaffar Pur' P.O. Small Industrial Estate' Sialkot "51310" Pakistan'

E-Mail: [info@alispo.com](mailto:info@alispo.com); [info@alispo.com.pk](mailto:info@alispo.com.pk) Web: [www.alispo.com](http://www.alispo.com); [www.alispo.com.pk](http://www.alispo.com.pk); [www.laparoscopysupplier.com](http://www.laparoscopysupplier.com)

Tel: +92-(0)-52-3 555674, 3254475 Fax: +92-(0)-52-3 556652, Cell: +92-(0)-300-8 717 212,



**Alispo** INTERNATIONAL

Manufacturers & Exporter of Surgical Instruments.

Molt Bone Currette. Hollow Handle # 1

**Alispo-80-480**

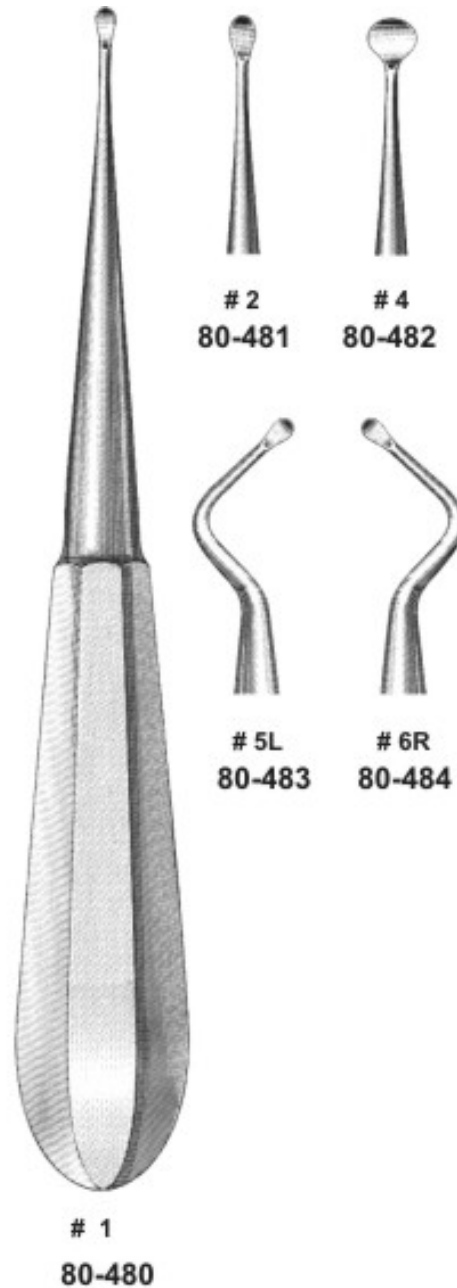

**MOLT**



**Alispo** INTERNATIONAL

Manufacturers & Exporter of Surgical Instruments.

**Molt Bone Curette Hollow Handle # 2**

**Alispo-80-481**



**MOLT**



**Alispo** INTERNATIONAL

Manufacturers & Exporter of Surgical Instruments.

**Molt Bone Curette Hollow Handle # 4**

**Alispo-80-482**

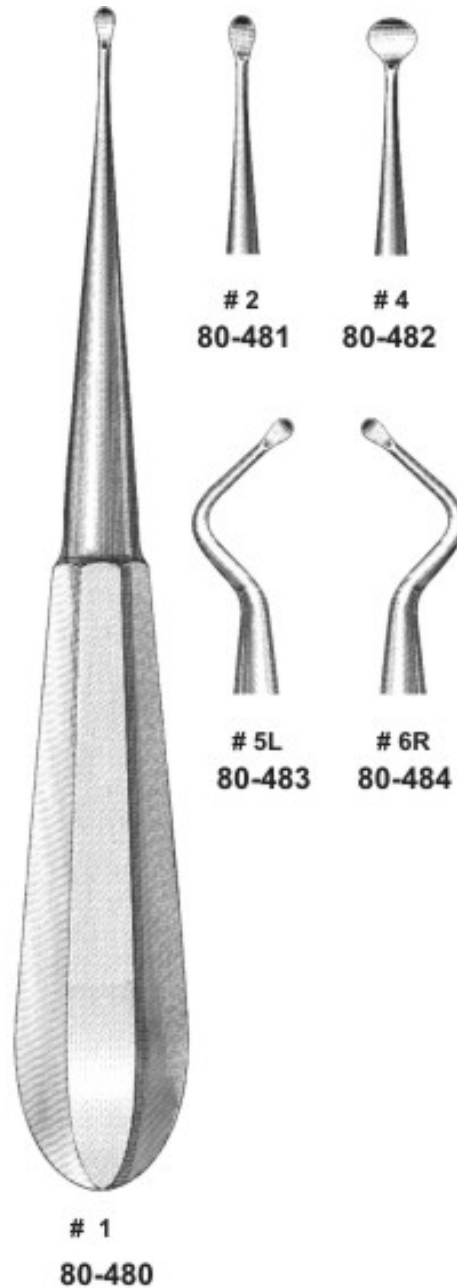

**MOLT**



**Alispo** INTERNATIONAL

Manufacturers & Exporter of Surgical Instruments.

Molt Bone Curette Hollow Handle # 5L

**Alispo-80-483**

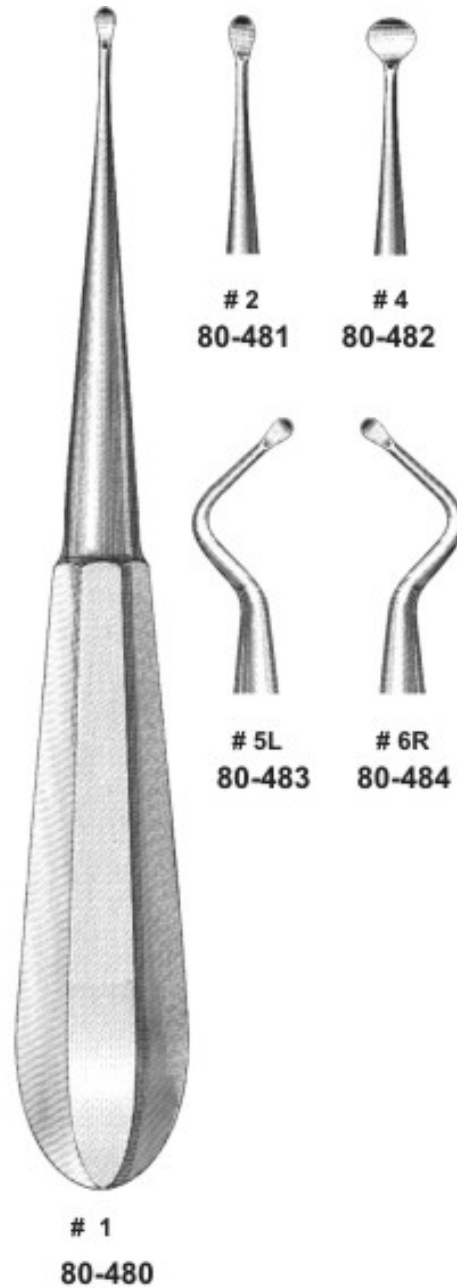

**MOLT**



**Alispo** INTERNATIONAL

Manufacturers & Exporter of Surgical Instruments.

**Molt Bone Curette Hollow Handle # 6R**

**Alispo-80-484**

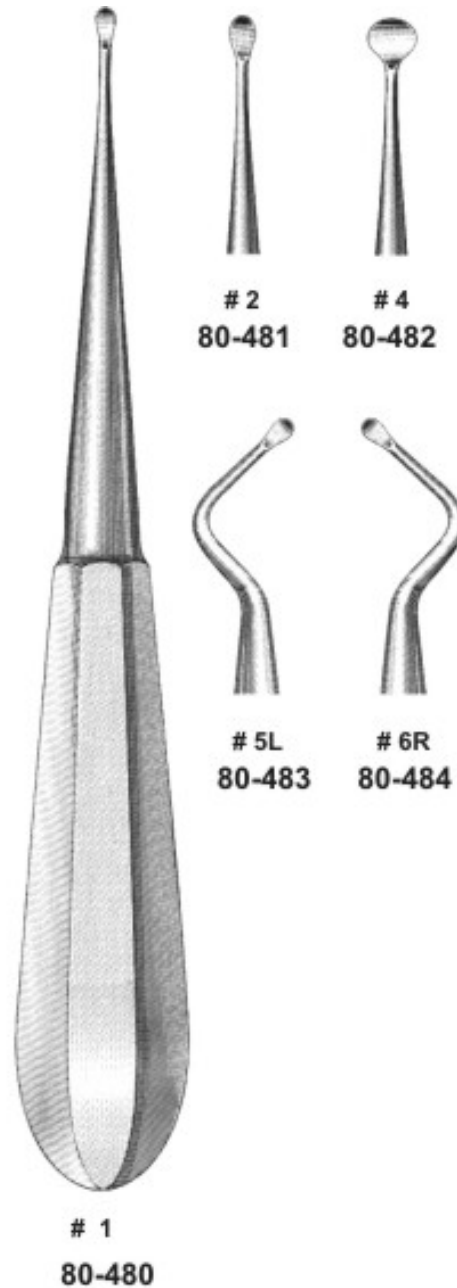

**MOLT**



**Alispo** INTERNATIONAL

Manufacturers & Exporter of Surgical Instruments.

Lucas Bone Curette # 75

**Alispo-80-490**

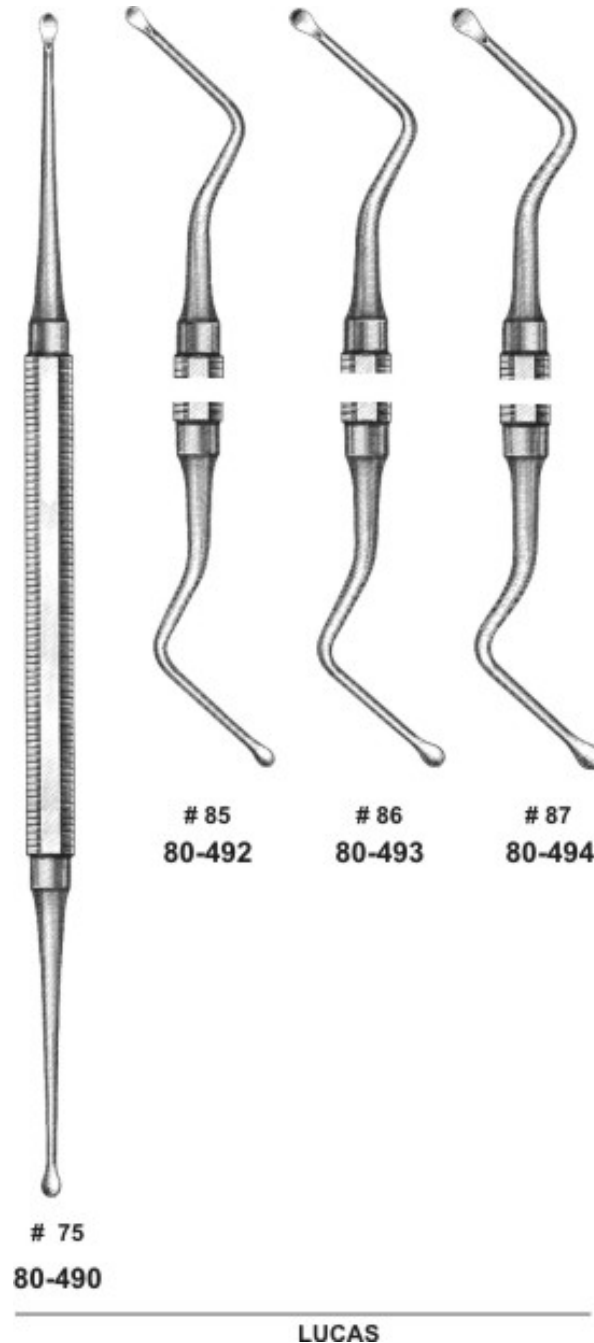



**Alispo** INTERNATIONAL

Manufacturers & Exporter of Surgical Instruments.

Lucas Bone Curette # 85

**Alispo-80-492**

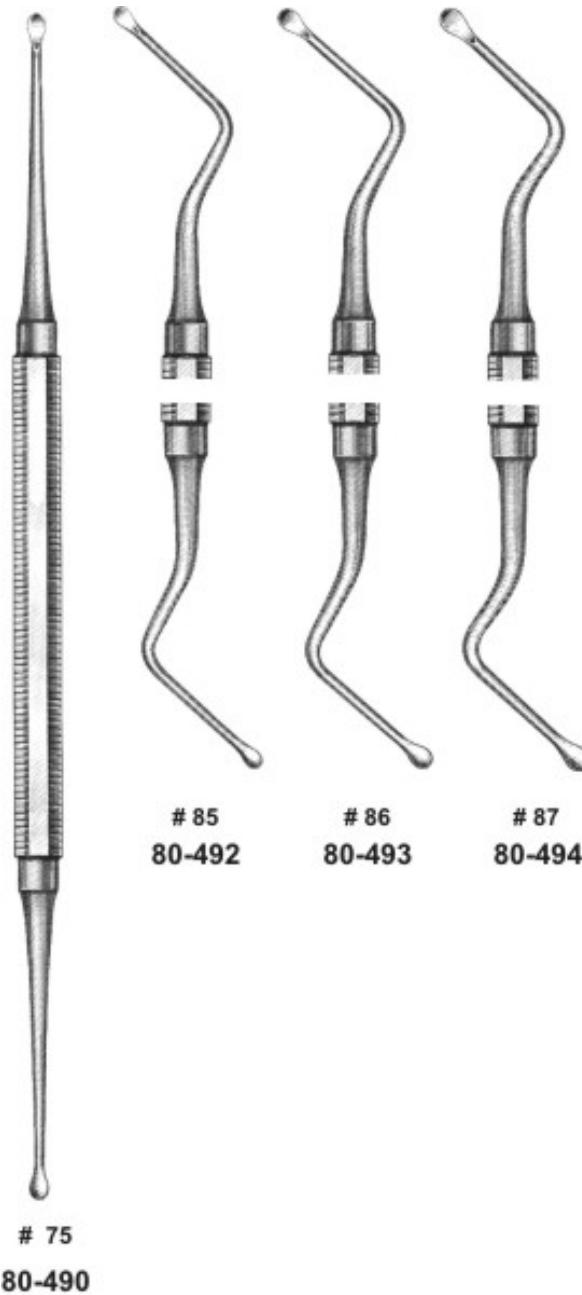

**LUCAS**



**Alispo** INTERNATIONAL

Manufacturers & Exporter of Surgical Instruments.

Lucas Bone Curette # 86

**Alispo-80-493**

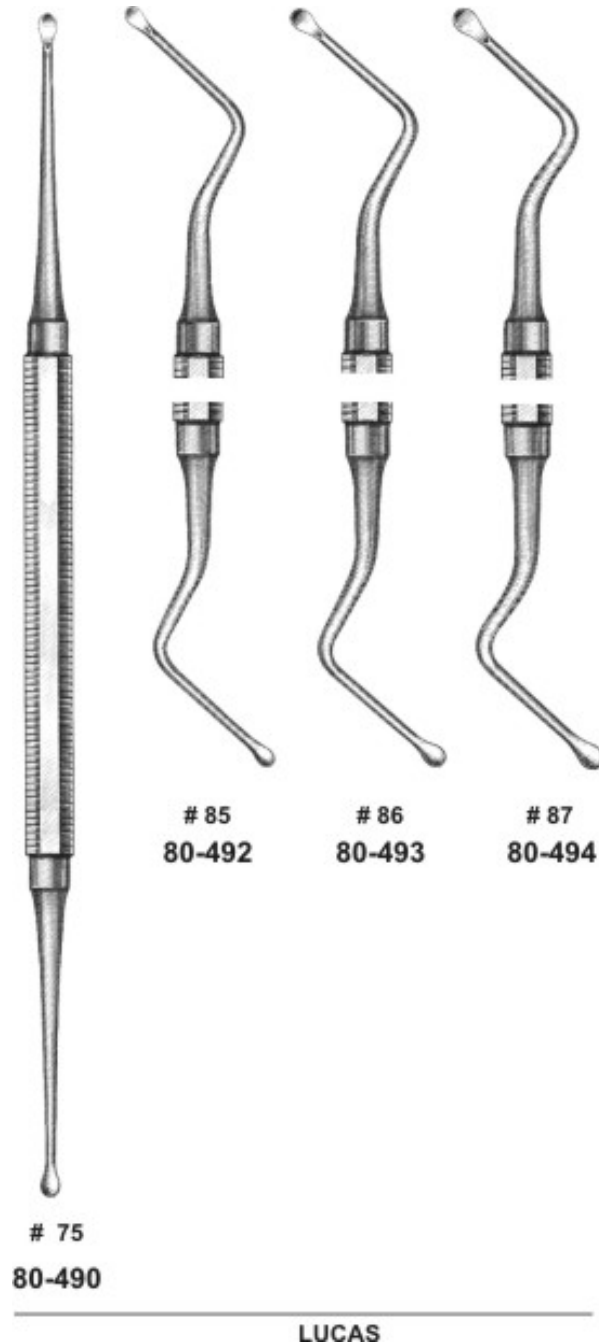

P.O. BOX-2872,

Roras Road' Muzaffar Pur' P.O. Small Industrial Estate' Sialkot "51310" Pakistan'

E-Mail: [info@alispo.com](mailto:info@alispo.com); [info@alispo.com.pk](mailto:info@alispo.com.pk) Web: [www.alispo.com](http://www.alispo.com); [www.alispo.com.pk](http://www.alispo.com.pk); [www.laparoscopysupplier.com](http://www.laparoscopysupplier.com)

Tel: +92-(0)-52-3 555674, 3254475 Fax: +92-(0)-52-3 556652, Cell: +92-(0)-300-8 717 212,



**Alispo** INTERNATIONAL

Manufacturers & Exporter of Surgical Instruments.

Lucas Bone Curette # 87

**Alispo-80-494**

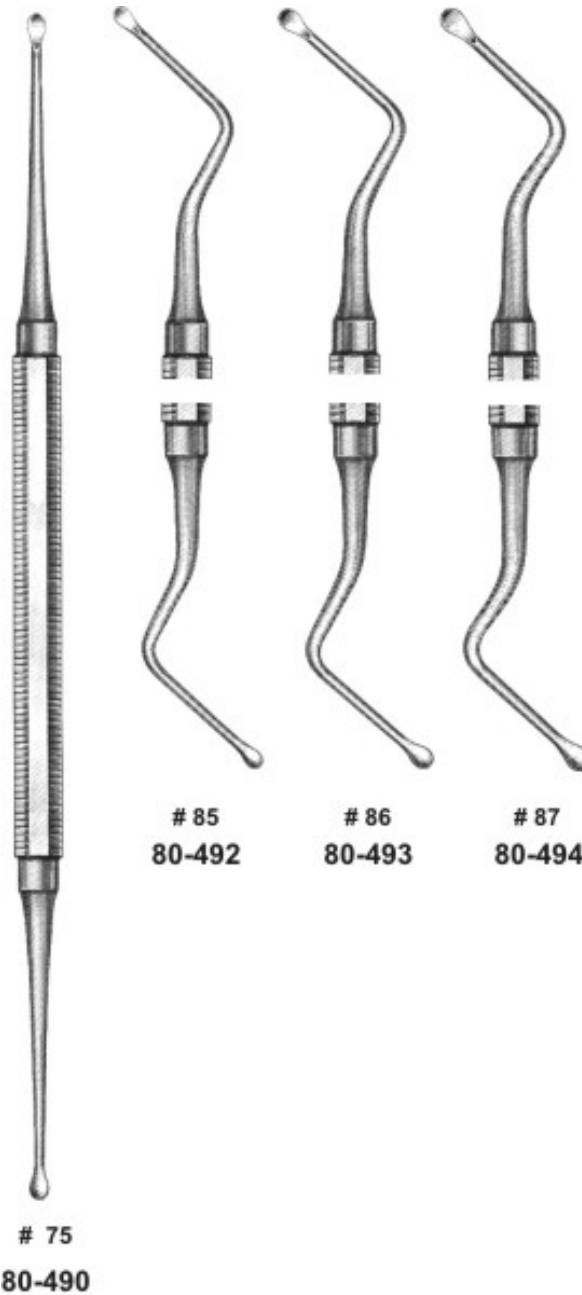

LUCAS



**Alispo** INTERNATIONAL

Manufacturers & Exporter of Surgical Instruments.

**Molt Bone Curette # 2/4**

**Alispo-80-500**



**# 2 / 4  
80-500  
MOLT**



**Alispo** INTERNATIONAL

Manufacturers & Exporter of Surgical Instruments.

Grander Bone Chisel # 1

**Alispo-80-520**

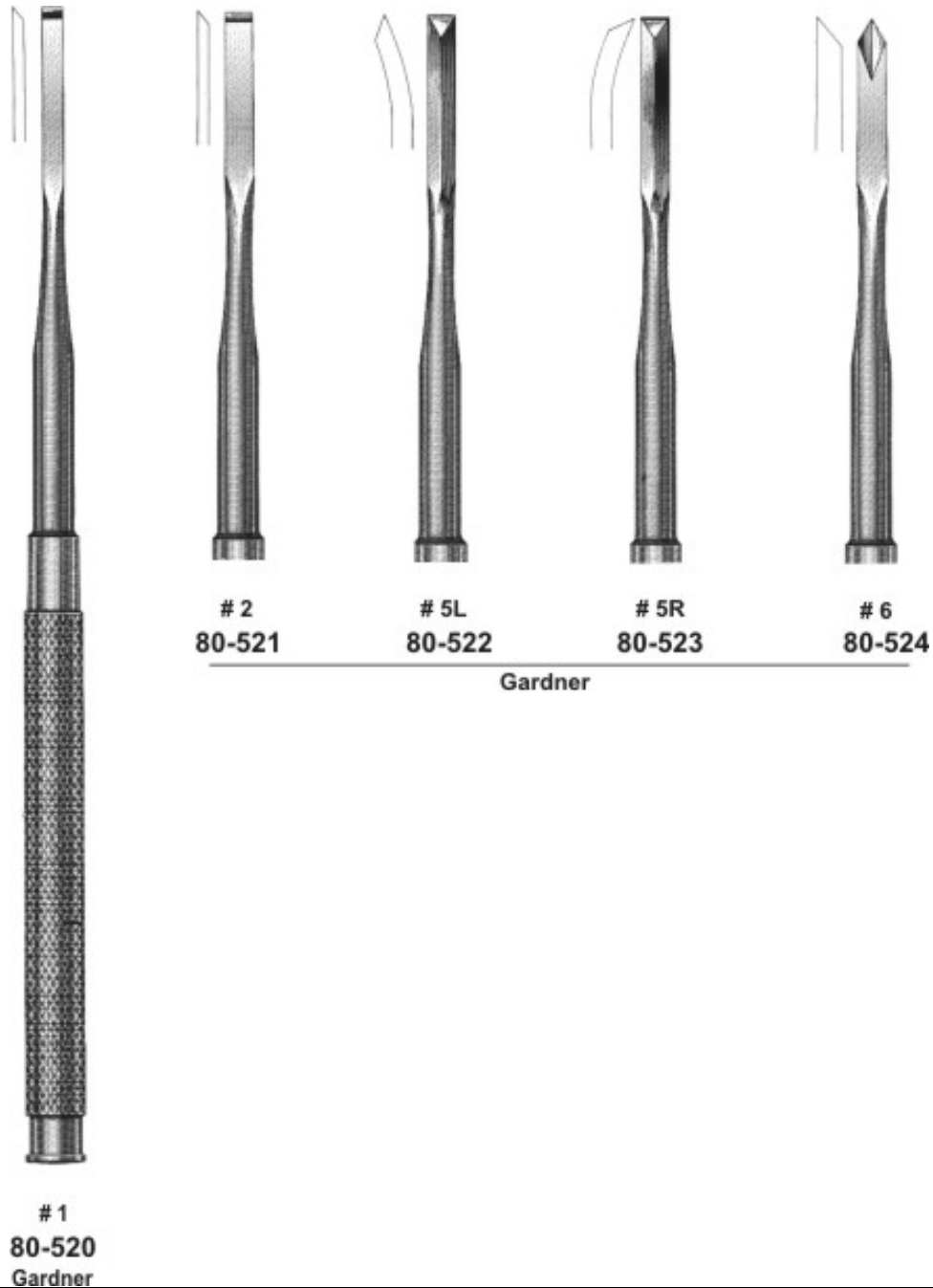

P.O. BOX-2872,

Roras Road' Muzaffar Pur' P.O. Small Industrial Estate' Sialkot "51310" Pakistan'

E-Mail: [info@alispo.com](mailto:info@alispo.com); [info@alispo.com.pk](mailto:info@alispo.com.pk) Web: [www.alispo.com](http://www.alispo.com); [www.alispo.com.pk](http://www.alispo.com.pk); [www.laparoscopysupplier.com](http://www.laparoscopysupplier.com)

Tel: +92-(0)-52-3 555674, 3254475 Fax: +92-(0)-52-3 556652, Cell: +92-(0)-300-8 717 212,



**Alispo** INTERNATIONAL

Manufacturers & Exporter of Surgical Instruments.

Grander Bone Chisel # 2

**Alispo-80-521**

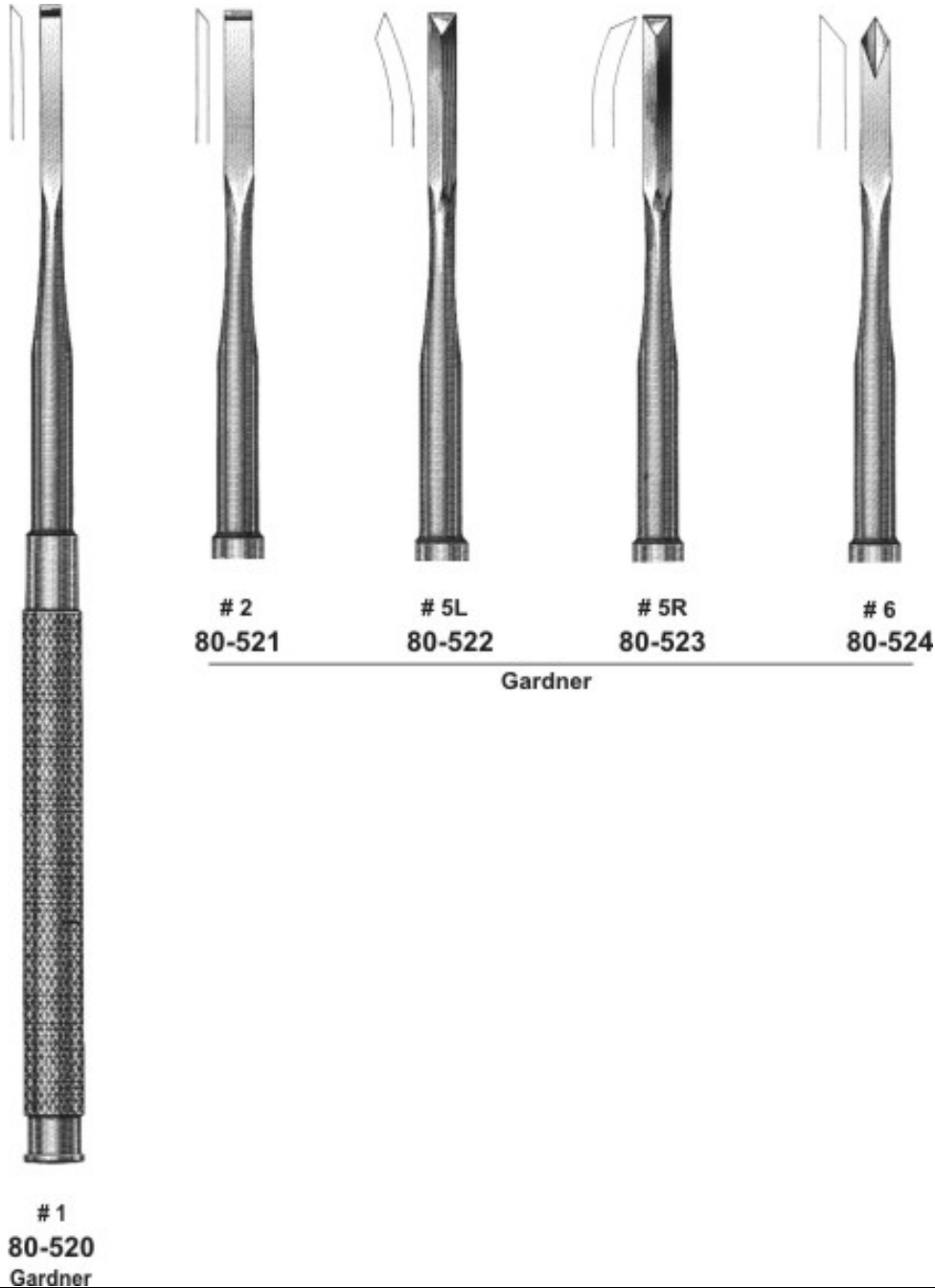

P.O. BOX-2872,

Roras Road' Muzaffar Pur' P.O. Small Industrial Estate' Sialkot "51310" Pakistan'

E-Mail: [info@alispo.com](mailto:info@alispo.com); [info@alispo.com.pk](mailto:info@alispo.com.pk) Web: [www.alispo.com](http://www.alispo.com); [www.alispo.com.pk](http://www.alispo.com.pk); [www.laparoscopysupplier.com](http://www.laparoscopysupplier.com)

Tel: +92-(0)-52-3 555674, 3254475 Fax: +92-(0)-52-3 556652, Cell: +92-(0)-300-8 717 212,



**Alispo** INTERNATIONAL

Manufacturers & Exporter of Surgical Instruments.

Grander Bone Chisel # 5L

**Alispo-80-522**

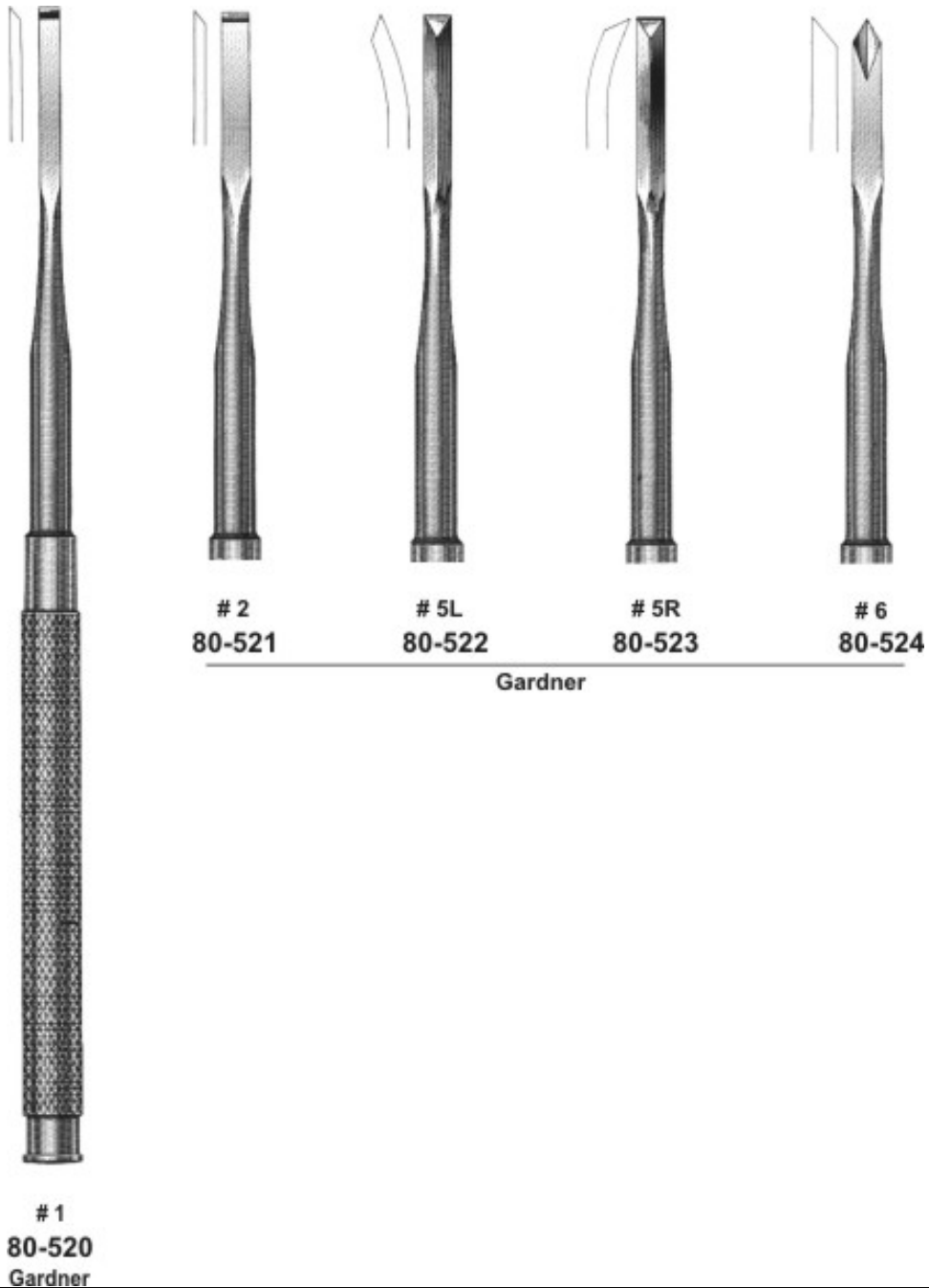

P.O. BOX-2872,

Roras Road' Muzaffar Pur' P.O. Small Industrial Estate' Sialkot "51310" Pakistan'

E-Mail: [info@alispo.com](mailto:info@alispo.com); [info@alispo.com.pk](mailto:info@alispo.com.pk) Web: [www.alispo.com](http://www.alispo.com); [www.alispo.com.pk](http://www.alispo.com.pk); [www.laparoscopysupplier.com](http://www.laparoscopysupplier.com)

Tel: +92-(0)-52-3 555674, 3254475 Fax: +92-(0)-52-3 556652, Cell: +92-(0)-300-8 717 212,



**Alispo** INTERNATIONAL

Manufacturers & Exporter of Surgical Instruments.

Grander Bone Chisel # 5R

**Alispo-80-523**

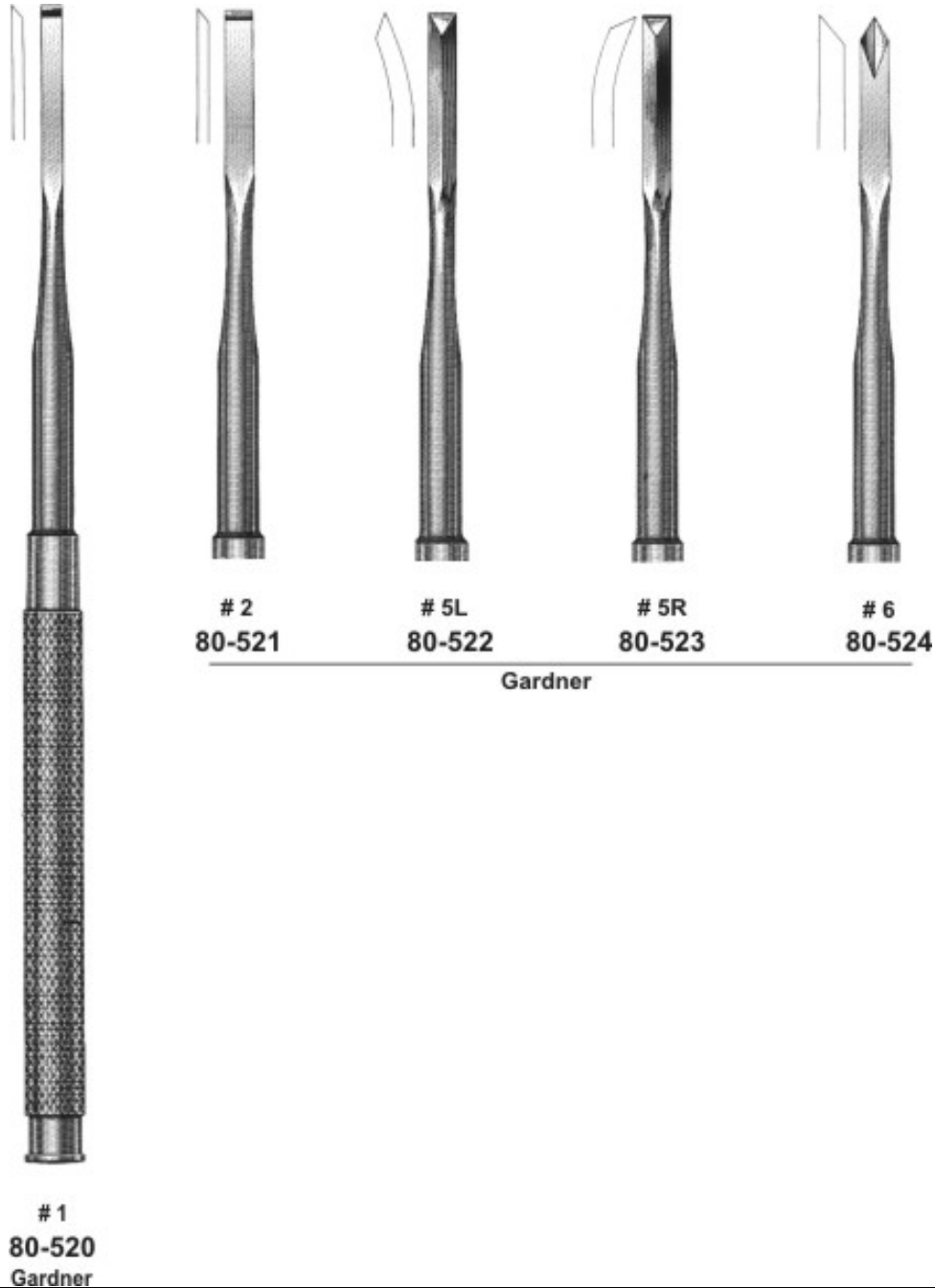

P.O. BOX-2872,

Roras Road' Muzaffar Pur' P.O. Small Industrial Estate' Sialkot "51310" Pakistan'

E-Mail: [info@alispo.com](mailto:info@alispo.com); [info@alispo.com.pk](mailto:info@alispo.com.pk) Web: [www.alispo.com](http://www.alispo.com); [www.alispo.com.pk](http://www.alispo.com.pk); [www.laparoscopysupplier.com](http://www.laparoscopysupplier.com)

Tel: +92-(0)-52-3 555674, 3254475 Fax: +92-(0)-52-3 556652, Cell: +92-(0)-300-8 717 212,



**Alispo** INTERNATIONAL

Manufacturers & Exporter of Surgical Instruments.

Grander Bone Chisel # 6

**Alispo-80-524**

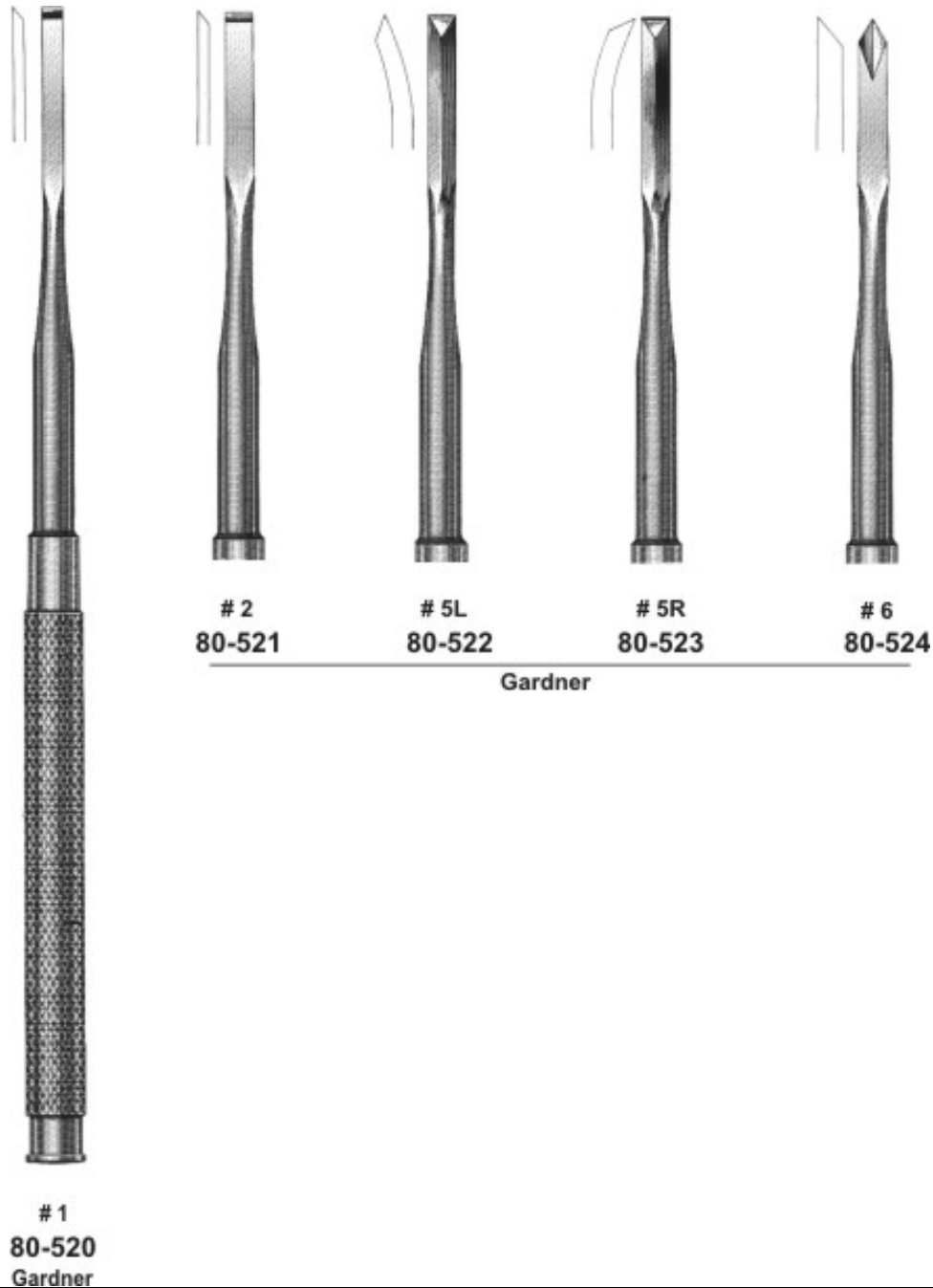

P.O. BOX-2872,

Roras Road' Muzaffar Pur' P.O. Small Industrial Estate' Sialkot "51310" Pakistan'

E-Mail: [info@alispo.com](mailto:info@alispo.com); [info@alispo.com.pk](mailto:info@alispo.com.pk) Web: [www.alispo.com](http://www.alispo.com); [www.alispo.com.pk](http://www.alispo.com.pk); [www.laparoscopysupplier.com](http://www.laparoscopysupplier.com)

Tel: +92-(0)-52-3 555674, 3254475 Fax: +92-(0)-52-3 556652, Cell: +92-(0)-300-8 717 212,



**Alispo** INTERNATIONAL

Manufacturers & Exporter of Surgical Instruments.

**Buckley Bone Chisel # 3**

**Alispo-80-525**

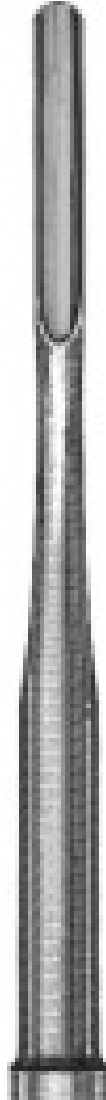

**# 3**

**80-525  
Buckley**



**Alispo** INTERNATIONAL

Manufacturers & Exporter of Surgical Instruments.

Wakefield Bone Chisel # 1W

**Alispo-80-530**

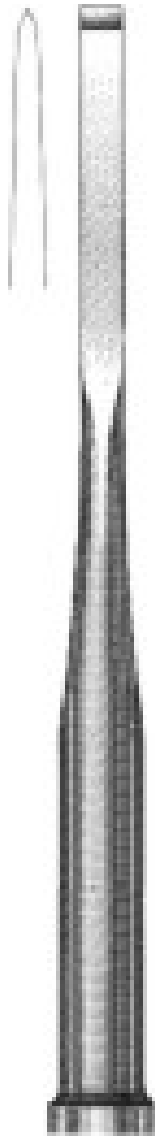

**# 1W  
80-530**

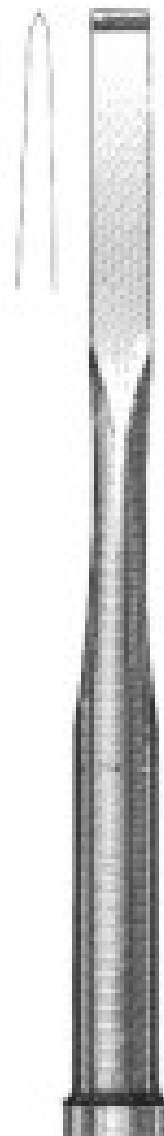

**# 2W  
80-531**

**Wakefield**



**Alispo** INTERNATIONAL

Manufacturers & Exporter of Surgical Instruments.

Wakefield Bone Chisel # 2W

**Alispo-80-531**

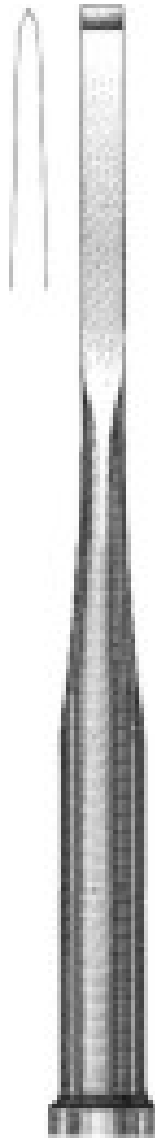

**# 1W**  
**80-530**

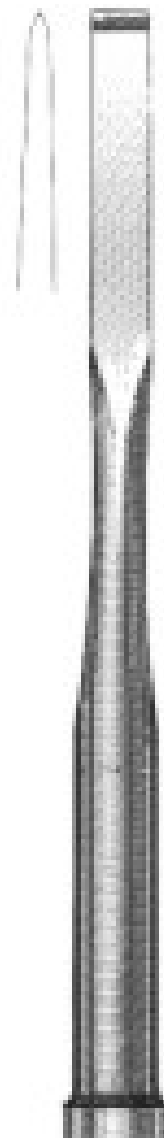

**# 2W**  
**80-531**

**Wakefield**



**Alispo** INTERNATIONAL

Manufacturers & Exporter of Surgical Instruments.

Ochsenbein Bone Chisel # 1

**Alispo-80-538**

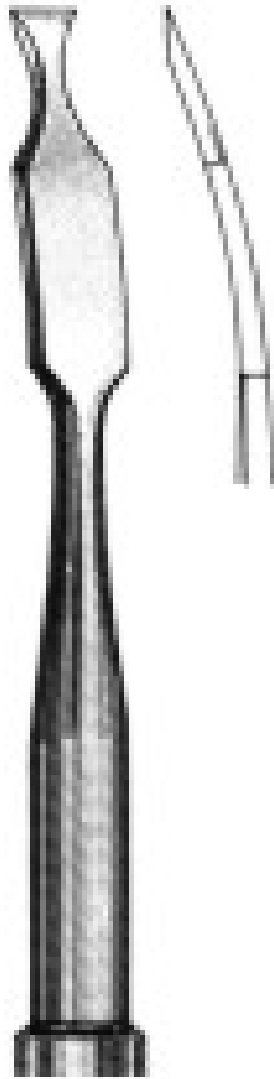

**# 1**  
**80-538**



**# 2**  
**80-539**

---

**Ochsenbein Chisel**



**Alispo** INTERNATIONAL

Manufacturers & Exporter of Surgical Instruments.

Ochsenbein Bone Chisel # 2

**Alispo-80-539**

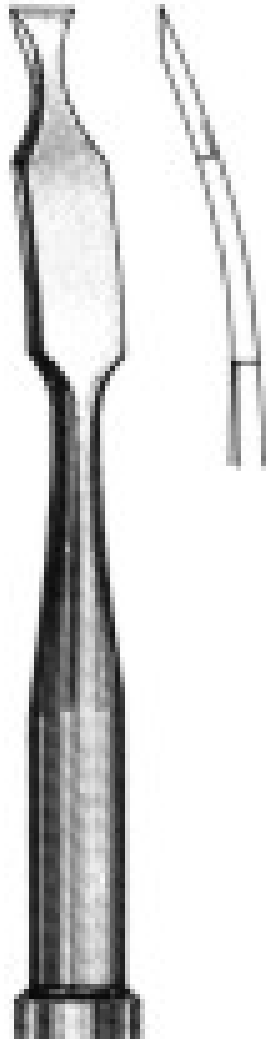

**# 1**  
**80-538**



**# 2**  
**80-539**

**Ochsenbein Chisel**